

# Industrial Shredders for Paper and Digital Media





# Paper | Optical

## High Security Data Destruction

700 Series shredders are NSA approved for the top-secret destruction of paper and optical media. They feature a powerful chain driven motor, an automatic EvenFlow Lubricator, and simple push button operation. These P-7/O-5 shredders are NSA rated for high volume shredding and hold up to 53 gallons of waste. They are precision engineered machines that support the high security shredding needs of military and government agencies.

### Media Types



### Special Features

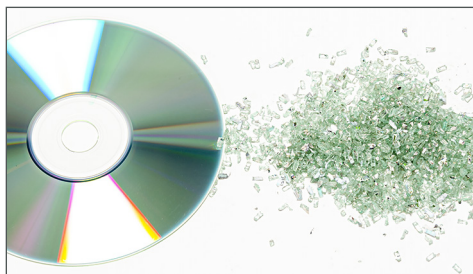
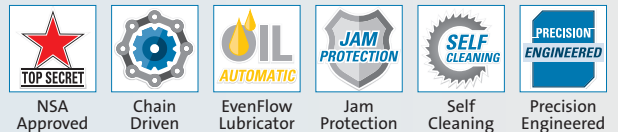

## 707 PS Paper Shredder

### High Security Paper Shredder

- NSA/CSS 02-01 Approved for Top-Secret data destruction
- Chain driven continuous duty motor for slip-free power
- Automatic EvenFlow Lubricator provides continuous oil
- Automatic jam protection eliminates frustration
- LED keypad with easy-to-use controls for simple operation
- Rubber shock mounts suspend the cutting head and reduce vibration
- Self-cleaning mode ensures optimal performance



## 717 OS Optical Shredder

### High Security Optical Media Shredder

- NSA/CSS 04-02 Approved for Top-Secret optical media destruction
- Chain driven continuous duty motor for slip-free power
- Automatic EvenFlow Lubricator provides continuous oil
- Automatic jam protection eliminates frustration
- LED keypad with easy-to-use controls for simple operation
- Rubber shock mounts suspend the cutting head and reduce vibration
- Self-cleaning mode ensures optimal performance

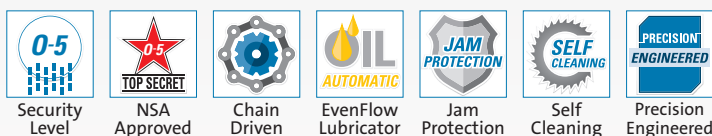

## 727 CS Combination Shredder

### High Security Paper | Optical Media Shredder

- NSA/CSS 02-01 / NSA/CSS 04-02 Approved for Top-Secret data destruction
- Powerful paper and optical media combination shredder
- Chain driven continuous duty motor for slip-free power
- Automatic EvenFlow Lubricator provides continuous oil
- Automatic jam protection eliminates frustration
- LED keypad with easy-to-use controls for simple operation
- Rubber shock mounts suspend the cutting head and reduce vibration

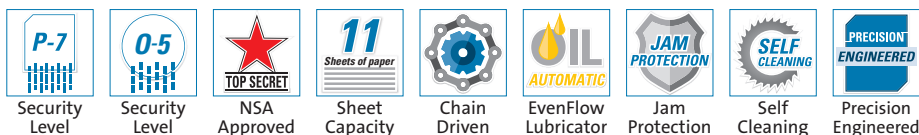

### SPECIFICATIONS

Model	Security Level	NSA Approved	Capacity #20 / #16	Shred Size	Waste Volume paper   media	Feed Width paper   media	Speed f/m	Motor	Decibel Level	Warranty Machine   Cylinders	Dimensions length x width x height	Weight	Power Supply
707 PS	P-7	Yes	11 / 13	1mm X 5mm	53 gal.	16"	24	3.5 Hp	55	2 Years   1 Year	21.75" x 28" x 43"	320 lbs	115v
717 OS	O-5	Yes	1 disc	2mm X 4mm	20 gal.	5"	9	2 Hp	55	2 Years   1 Year	19.75" x 22.75" x 32.25"	165 lbs	115v
727 CS	P-7   O-5	Yes	11 / 13	1mm X 5mm	33 gal.   20 gal.	9"   5"	24	3.5 Hp	55	2 Years   1 Year	21.75" x 28" x 43"	330 lbs	115v



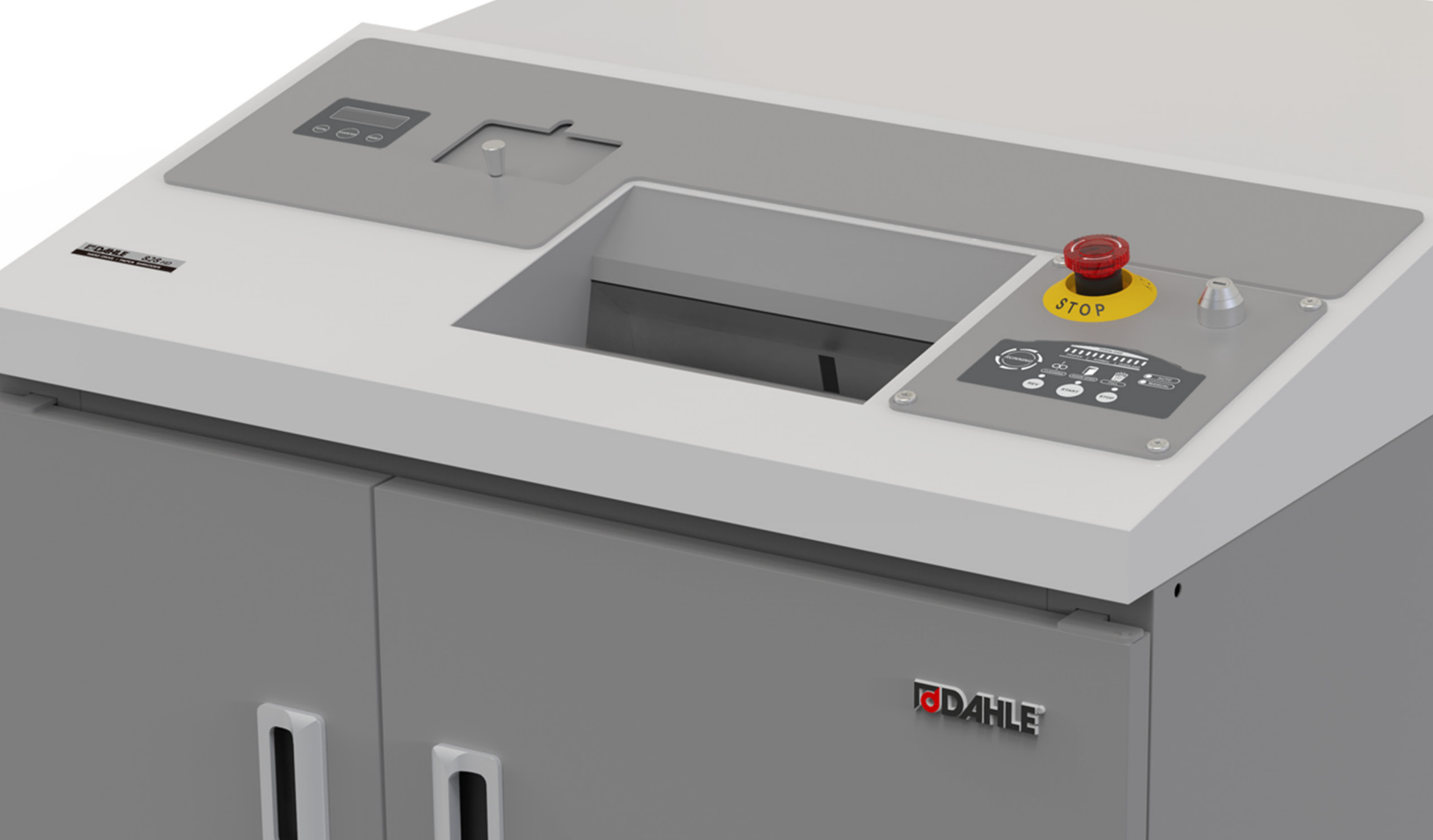

# Digital Media

For Hard Drive | SSD | Cell Phone | and Optical Media Destruction

800 Series shredders are the perfect machines for safely destroying hard drives, SSDs, cell phones, optical media, and paper. They feature a powerful chain driven motor, automatic jam protection, and simple push button operation. These multimedia shredders are precision engineered to ensure your confidential digital media can never be seen again.

## Media Types

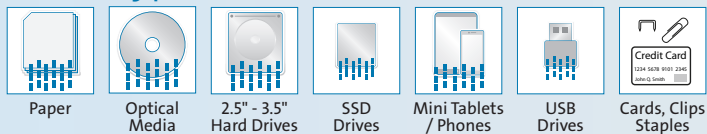

## Special Features

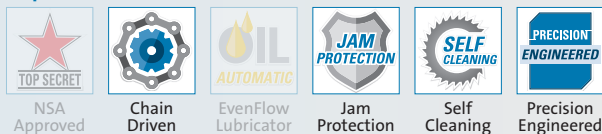

## 808 MS Media Shredder

Shreds SSDs | Cell Phones | USB Drives | Mini Tablets | Optical Media

- Security Level O-3 / E-3 for the destruction of confidential digital media
- Chain driven continuous duty motor for slip-free power
- Jam protection- Machine cycles back and forth until shredding is complete
- LED keypad with easy-to-use controls for simple operation
- Rubber shock mounts suspend the cutting head and reduce vibration
- Self-cleaning mode ensures optimal performance
- For safety, the shredder stops when the door or feed cover are opened

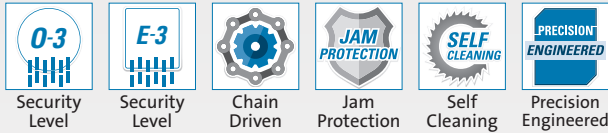

## 818 HD Hard Drive Punch

Punches 3.5" & 2.5" Hard Drives

- NSA Approved for hard drive destruction
- Security Level H-3 for the destruction of confidential digital media
- Hardened nickel-plated punch renders hard drives unreadable
- Chain driven continuous duty motor for slip-free power
- Illuminated chute opening with transparent safety cover
- LED keypad with easy-to-use controls for simple operation
- Rubber shock mounts suspend the motor and reduce vibration

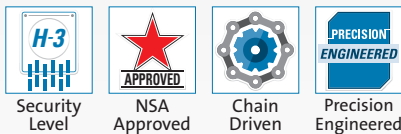

## 828 HD Hard Drive Shredder

Shreds Hard Drives | SSDs | Cell Phones | Optical Media | Paper

- Security Level H-4 / P-3 for the destruction of sensitive information
- Mighty 4.5 Hp continuous duty motor with chain driven operation
- Jam protection- Machine cycles back and forth until shredding is complete
- LED keypad with easy-to-use controls for simple operation
- Rubber shock mounts suspend the cutting head and reduce vibration
- Self-cleaning mode ensures optimal performance
- For safety, the shredder stops when the doors are opened

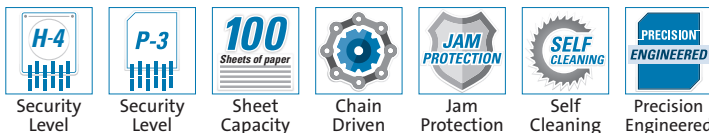

### SPECIFICATIONS

Model	Security Level	NSA Approved	Capacity #20 / #16	Shred Size paper   media	Waste Volume paper   media	Feed Width paper   media	Motor	Decibel Level	Warranty	Dimensions length x width x height	Weight	Power Supply
808 MS	O-3   E-3		1 drive	4mm X 15mm	4 gal.	6.5"	3.5 Hp	55	1 year	21.75" x 21.75" x 39.5"	287 lbs	115v
818 HD	H-3	Yes	1 drive		27 gal.	4.7"	.75 Hp	60	1 year	19.75" x 20" x 34.5"	154 lbs	115v
828 HD	H-4   P-3		100 / 110	5mm X 70mm   40mm X 40-90mm	31 gal.   26 gal.	11.8"   4.7"	4.5 Hp	60	1 year	38.25" x 33.5" x 46.5"	1,257 lbs	220v 3 Phase



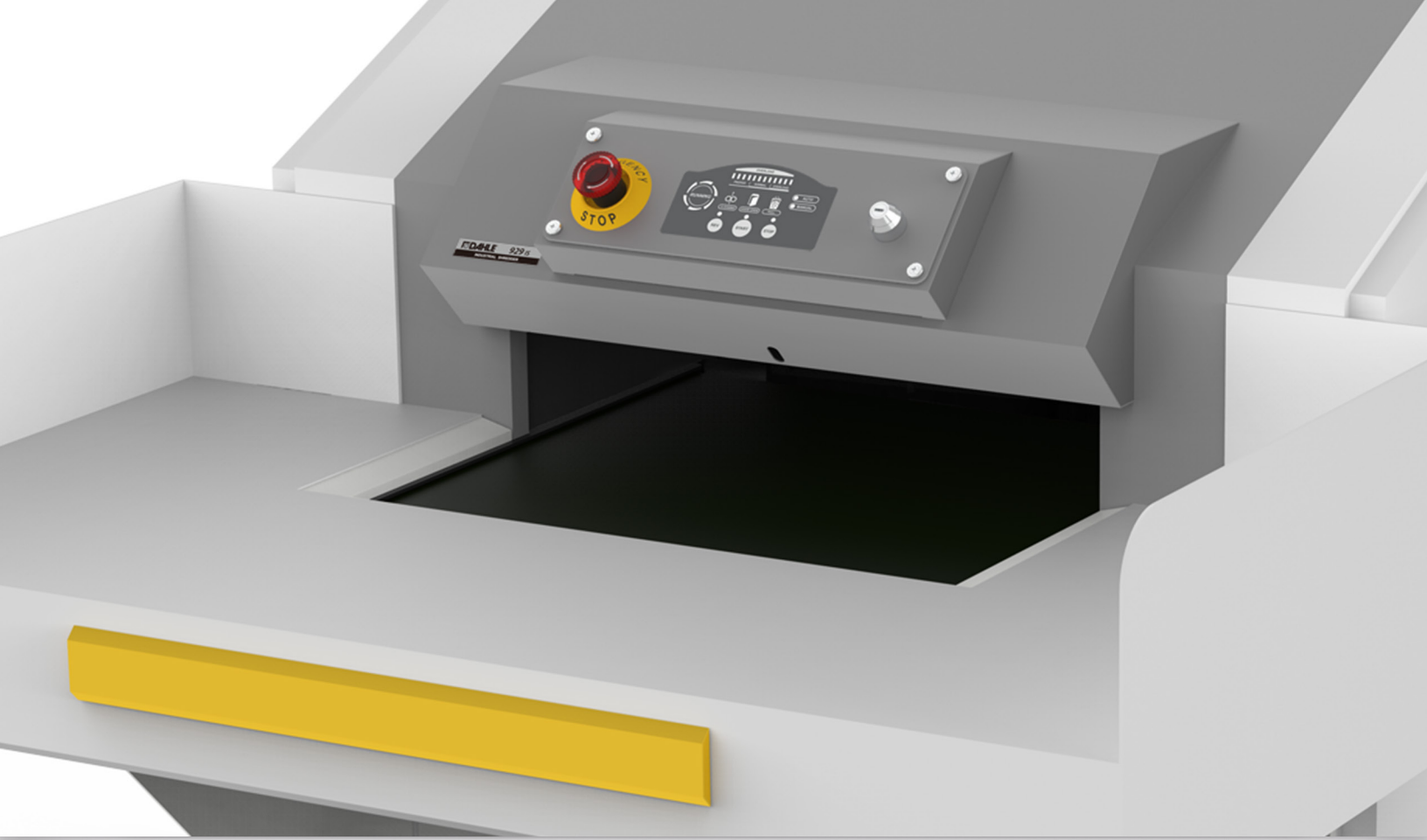

# Industrial

## High Volume Data Destruction

900 Series Industrial Shredders are high capacity machines capable of destroying large volumes of sensitive information quickly. They feature a powerful chain driven motor, automatic jam protection, and simple push button operation. These shredders are rated for Security Level P-3 destruction and can hold up to 120 gallons of waste. For added convenience, output conveyor belts are available for the PowerTEC® 919 IS and 929 IS to deliver shredded waste to a large recycling bin or baler.

### Media Types



### Special Features

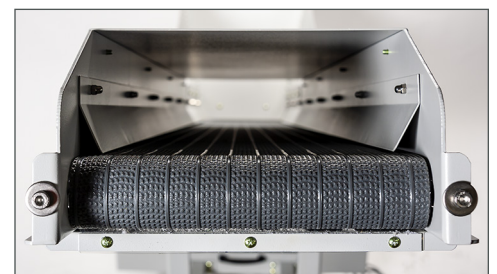
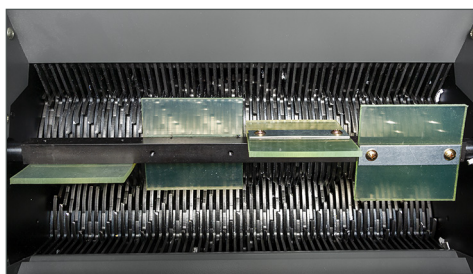
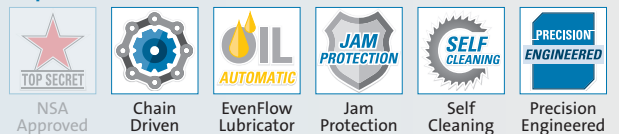

# 909 HS Industrial Shredder

Shreds High Volume Paper | Optical Media

- Security Level P-3 for the destruction of sensitive information
- Mighty 5 Hp continuous duty motor with chain driven operation
- Automatic EvenFlow Lubricator provides continuous oil
- Automatic jam protection eliminates frustration
- LED keypad with easy-to-use controls for simple operation
- Self-cleaning mode ensures optimal performance
- Center folding table can be lifted and used for high volume shredding



Security Level	Sheet Capacity	Chain Driven	EvenFlow Lubricator	Jam Protection	Self Cleaning	Precision Engineered

# 919 IS Industrial Shredder

Shreds High Volume Paper | Binders | Optical Media

- Security Level P-3 for the destruction of sensitive information
- Mighty 5 Hp continuous duty motor with chain driven operation
- Automatic EvenFlow Lubricator provides continuous oil
- Automatic jam protection eliminates frustration
- LED keypad with easy-to-use controls for simple operation
- Rubber shock mounts suspend the cutting head and reduce vibration
- Optional output conveyor (919 CB) available for high volume waste disposal

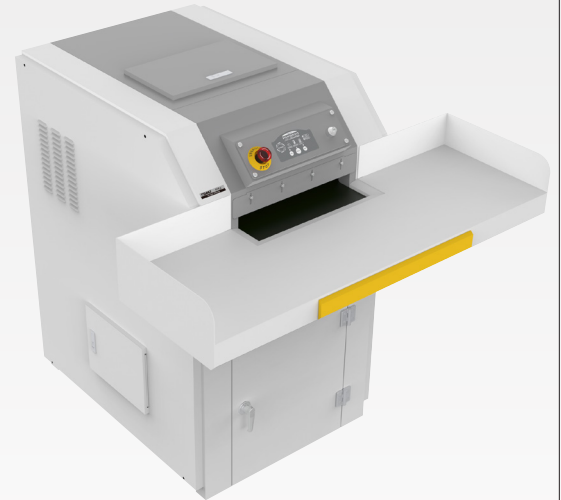

Security Level	Sheet Capacity	Chain Driven	EvenFlow Lubricator	Jam Protection	Self Cleaning	Precision Engineered

# 929 IS Industrial Shredder

Shreds High Volume Paper | Binders | Optical Media

- Security Level P-3 for the destruction of sensitive information
- Mighty 11.5 Hp continuous duty motor with chain driven operation
- Automatic EvenFlow Lubricator provides continuous oil
- Automatic jam protection eliminates frustration
- LED keypad with easy-to-use controls for simple operation
- Rubber shock mounts suspend the cutting head and reduce vibration
- Optional output conveyor (929 CB) available for high volume waste disposal



Security Level	Sheet Capacity	Chain Driven	EvenFlow Lubricator	Jam Protection	Self Cleaning	Precision Engineered

## SPECIFICATIONS

Model	Security Level	Capacity #20 / #16	Shred Size	Waste Volume paper   media	Feed Width paper   media	Speed f/m	Motor	Decibel Level	Warranty	Dimensions length x width x height	Weight	Power Supply
909 HS	P-3	85 / 90	4mm X 50mm	68 gal.	17.5"	39	5 Hp	60	1 year	30" x 30" x 64.25"	992 lbs	220v 3 Phase
919 IS	P-3	85 / 90	5mm X 40mm	45 gal.	16"	39	5 Hp	65	1 year	52" x 47.25" x 48.5"	1,080 lbs	220v 3 Phase
929 IS	P-3	500	8mm X 40mm	120 gal.	21.5"	33	11.5 Hp	70	1 year	78.75" x 48" x 64.5"	3,175 lbs	220v 3 Phase



## 919 CB Conveyor Belt

*Output Conveyor Belt for PowerTEC® 919 IS*

- 16 Inch wide rubber conveyor belt rapidly removes shredded waste
- Provides unlimited waste volume to PowerTEC® 919 IS
- 50" delivery height for easy placement above a recycling bin or baler
- Adjustable output speed with the turn of a dial
- Plugs directly into PowerTEC® 919 IS- no additional power needed
- Steel construction with rolling casters for easy placement



## 929 CB Conveyor Belt

*Output Conveyor Belt for PowerTEC® 929 IS*

- Extra large 21.5 inch wide rubber conveyor belt rapidly removes waste
- Provides unlimited waste volume to PowerTEC® 919 IS
- 46" delivery height for easy placement above a recycling bin or baler
- Adjustable output speed with the turn of a dial
- Plugs directly into PowerTEC® 929 IS- no additional power needed
- Steel construction with rolling casters for easy placement

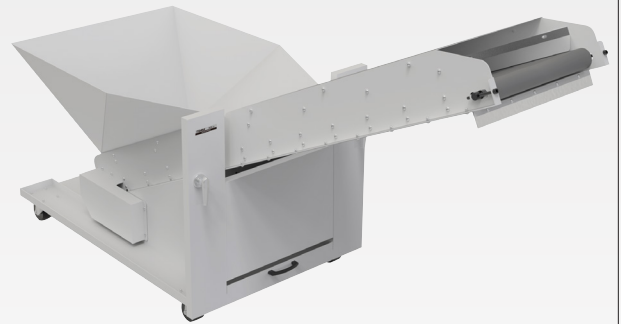

### SPECIFICATIONS

Model	Belt Width	Speed f/m	Decibel Level	Warranty	Dimensions length x width x height	Weight	Power Supply
919 CB	16"	49	65	1 year	92.25" x 25.75" x 50.5"	276 lbs	220v (plugs into 919 IS)
929 CB	21.5"	49	65	1 year	83.25" x 30" x 46"	276 lbs	220v (plugs into 929 IS)

