

Casework Specification Guide

EFFECTIVE 9.1.14

HAMILTON caseworks is a manufactured laminate product that gives designers and end-users a modular, flexible and durable alternative to built in millwork.

HAMILTON products are designed to meet the rigorous conditions of today's work environment.

HAMILTON is dedicated to providing custom-tailored modular casework that meets specific needs and delivers a perfect fit, every time.

All of our casework is backed with HAMILTON's Limited Lifetime Warranty.

CONSTRUCTION

- Cabinets are primarily constructed of 3/4" thick industrial grade 40-50 lb. substrate, double-faced melamine.
- All exposed edges are covered with 2mm PVC edge banding.
- Work surfaces are constructed of 1 1/16" thick high-pressure laminate (HPL) with industrial grade 40-50 lb. substrate backed with a .027 phenolic backer.
- Parts are drilled using a 32mm hole drilling via computer controlled point-to-point machines for insured uniformity and consistency.
- Our easy-to-install rail mounted wall cabinets provide precise height and depth adjustments for clean installation and the look of custom millwork.
- Hamilton's unique adjustable shelf system utilizes .90-gauge polyethylene shelves with full-width indexing and adjusts on 1" increments on our exclusive full depth channel guides.
- Hamilton uses only the highest quality hardware, such as full extension ball bearing slides with soft close options and concealed tool-less hinges for a lifetime of worry free operation; as well as multiple handle pull options allowing you to personalize your selection.

Table of Contents

Green Initiatives	2
Sustainability Guidelines	3
Base Cabinets	4
How to Specify	
Product Line	
Storage Cabinets	20
How to Specify	
Product Line	
Wall Cabinets	28
How to Specify	
Product Line	
Corner Cabinets	34
How to Specify	
Base Corner Cabinet Products	11
Wall Corner Cabinet Products	33
Specialty	38
Work Surfaces	42
How to Specify	
Product Line	
Back Splash	45
How to Specify	
Product Line	
Accessories	48
How to Specify	
Product Line	
Selecting Sorter Shelves Accessories	53
Handles	54
Laminates	55
Lifetime Guarantee	Back Cover

Green Initiatives

Hamilton Casework Solutions offer GREENGUARD Gold certified products to provide safe, quality, environmentally friendly workspaces. FSC and OSHPD certified components are also available as specified by a designer.

Our approach to sustainability is in line with everything else that we do at HAMILTON. We are deeply committed to delivering to your project's needs and providing the perfect fit, every time. For many clients, a comprehensive solution means pursuing green initiatives.

We embrace the sustainability concerns that our clients bring to us by:

- Conducting the research necessary to find goods currently available on the market that are compliant

We are casework experts. We are always on the lookout for innovative new materials in our area of specialty.

- Partnering with clients to form a strategy

We encourage our clients to identify and discuss their sustainability intentions with us so that we can ensure Hamilton components help them achieve their targeted goals. The earlier you involve us in the planning of your project, the more we can help.

- Brainstorming for solutions

We have tremendous practical knowledge and our design studio is located yards away from the factory floor. We can accommodate your green initiatives while maintaining the design integrity of the project.

Sustainability Guidelines

HAMILTON will provide proper documentation for the rating system of your choice. We have extensive experience with LEED, and have obtained a Declare label for our products. We are active with current sustainability efforts in the A&D community like Environmental Product Declarations (EPD) .

- Our product is found in CSI Division 12, under 12 32 16 Manufactured Plastic-Laminate-Clad Casework and 12 35 36 Mailroom Casework.
- The HAMILTON modular casework product is an “assembly,” project specific documentation including material percentage by weight provided upon request.
- All HAMILTON products contain recycled content, and may contribute to regional credits depending on project location.
- HAMILTON products do not require adhesives or sealants to be applied on-site, and all shop applied laminating adhesives contain No Added Urea Formaldehyde (NAUF).
- HAMILTON is FSC Chain of Custody certified. Upon request, our casework products can be ordered to comply with FSC requirements.
- All HAMILTON products are GREENGUARD Gold Certified to comply with the ANSI/BIFMA standards, and can be ordered to comply with NAUF and ULEF requirements.

HAMILTON sustainability experts will provide consultation every step of the way to facilitate the success of your project.

Base Cabinets

How to Specify Your Options

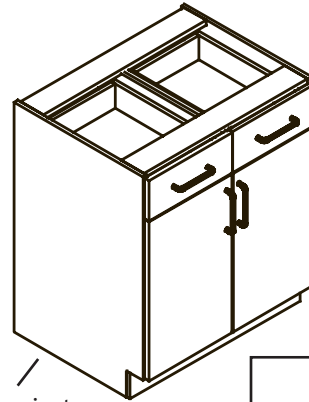

Door Front Options	
Model	Materials
LAM	Laminate
TFH	Thermofoil Harper
TFC	Thermofoil Celadon
TFP	Thermofoil Pavilion
FAC	Thermofoil/Acrylic-clear
FAF	Thermofoil/Acrylic-frosted
FGC	Thermofoil/Glass-clear
FGF	Thermofoil/Glass-frosted
AAC	Alum/Acrylic/clear
AAF	Alum/Acrylic-frosted
AGC	Alum/Glass-clear
AGF	Alum/Glass-frosted

Handle Options		
Model	Description	
EL	Elliptical Black	007B
ES	Elliptical Silver	001A
CB	Crescent Black	007A
CS	Crescent Silver	117A
TC	Textured Crescent	100A
FC	Flared Crescent	101A
RS	Recessed Silver	999
WP	Wired Pull	102A
BS	6" Bar Handle	103A
BE	8" Bar Handle	104A
BT	10" Bar Handle	105A

Door Lock Options	
Model	Description
Y	Locking doors
N	No locks

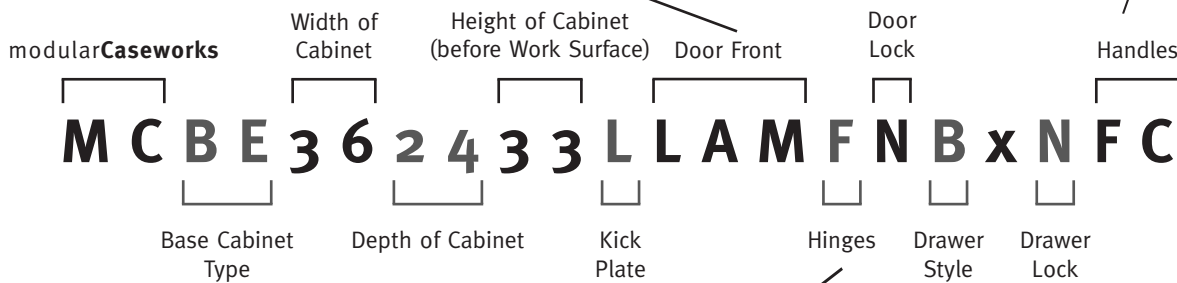

Kick Plate Options	
Model	Description
L	Laminate
P	Powder coated steel
S	Stainless steel
M	Laminate w/panel attachment
Q	Powder coat w/panel attachment
T	Stainless steel w/panel attachment

Drawer Lock Options	
Model	Description
Y	Locking drawers
N	No locks

Hinge Options	
Model	Description
O	Overlay 110 degree
S	110 degree soft close
F	270 degree
K	5 knuckle

Drawer Options	
Model	Description
B	Ball Bearing Slide*
R	Nylon Roller Slide*
U	Under Mount Slide*
C	Under Mount Slide with soft close*
M	Moovit Drawer System**

*White vinyl wrap
**Metal sides

Base Cabinet Products

Doors and Adjustable Shelf

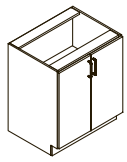

MCBA

MODEL #	WIDTH	DEPTH	HEIGHT	WEIGHT
MCBA242429	24	24	29	91
MCBA242433	24	24	33	99
MCBA242435	24	24	35	102
MCBA242437	24	24	37	108
MCBA242441	24	24	41	114
MCBA243029	24	30	29	104
MCBA243033	24	30	33	113
MCBA243035	24	30	35	117
MCBA243037	24	30	37	125
MCBA243041	24	30	41	132
MCBA302429	30	24	29	106
MCBA302433	30	24	33	115
MCBA302435	30	24	35	119
MCBA302437	30	24	37	127
MCBA302441	30	24	41	134
MCBA303029	30	30	29	121
MCBA303033	30	30	33	130
MCBA303035	30	30	35	134
MCBA303037	30	30	37	141
MCBA303041	30	30	41	148
MCBA362429	36	24	29	121
MCBA362433	36	24	33	130
MCBA362435	36	24	35	135
MCBA362437	36	24	37	143
MCBA362441	36	24	41	151
MCBA363029	36	30	29	137
MCBA363033	36	30	33	147
MCBA363035	36	30	35	152
MCBA363037	36	30	37	161
MCBA363041	36	30	41	169
MCBA422429	42	24	29	136
MCBA422433	42	24	33	146
MCBA422435	42	24	35	151
MCBA422437	42	24	37	160
MCBA422441	42	24	41	168
MCBA423029	42	30	29	153
MCBA423033	42	30	33	165
MCBA423035	42	30	35	170
MCBA423037	42	30	37	180
MCBA423041	42	30	41	189

No upcharge to modify dimensions.

Left Door and Adjustable Shelf

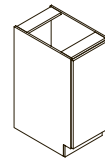

MCBB

MODEL #	WIDTH	DEPTH	HEIGHT	WEIGHT
MCBB122429	12	24	29	62
MCBB122433	12	24	33	67
MCBB122435	12	24	35	70
MCBB122437	12	24	37	75
MCBB122441	12	24	41	79
MCBB123029	12	30	29	71
MCBB123033	12	30	33	78
MCBB123035	12	30	35	81
MCBB123037	12	30	37	87
MCBB123041	12	30	41	92
MCBB152429	15	24	29	69
MCBB152433	15	24	33	75
MCBB152435	15	24	35	78
MCBB152437	15	24	37	83
MCBB152441	15	24	41	88
MCBB153029	15	30	29	80
MCBB153033	15	30	33	87
MCBB153035	15	30	35	90
MCBB153037	15	30	37	96
MCBB153041	15	30	41	101
MCBB182429	18	24	29	77
MCBB182433	18	24	33	83
MCBB182435	18	24	35	86
MCBB182437	18	24	37	91
MCBB182441	18	24	41	96
MCBB183029	18	30	29	88
MCBB183033	18	30	33	95
MCBB183035	18	30	35	99
MCBB183037	18	30	37	105
MCBB183041	18	30	41	111
MCBB212429	21	24	29	84
MCBB212433	21	24	33	91
MCBB212435	21	24	35	94
MCBB212437	21	24	37	100
MCBB212441	21	24	41	105
MCBB213029	21	30	29	96
MCBB213033	21	30	33	104
MCBB213035	21	30	35	108
MCBB213037	21	30	37	115
MCBB213041	21	30	41	122
MCBB232429	23	24	29	84
MCBB232433	23	24	33	91
MCBB232435	23	24	35	94
MCBB232437	23	24	37	100
MCBB232441	23	24	41	105
MCBB233029	23	30	29	96
MCBB233033	23	30	33	104
MCBB233035	23	30	35	108

Left Door and Adjustable Shelf (cont.)

MODEL #	WIDTH	DEPTH	HEIGHT	WEIGHT
MCBB233037	23	30	37	115
MCBB233041	23	30	41	122

No upcharge to modify dimensions.

Right Door and Adjustable Shelf (cont.)

MODEL #	WIDTH	DEPTH	HEIGHT	WEIGHT
MCBC232437	23	24	37	100
MCBC232441	23	24	41	105
MCBC233029	23	30	29	96
MCBC233033	23	30	33	104
MCBC233035	23	30	35	108
MCBC233037	23	30	37	115
MCBC233041	23	30	41	122

No upcharge to modify dimensions.

Right Door and Adjustable Shelf

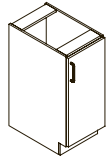

MCBC

MODEL #	WIDTH	DEPTH	HEIGHT	WEIGHT
MCBC122429	12	24	29	62
MCBC122433	12	24	33	67
MCBC122435	12	24	35	70
MCBC122437	12	24	37	75
MCBC122441	12	24	41	79
MCBC123029	12	30	29	71
MCBC123033	12	30	33	78
MCBC123035	12	30	35	81
MCBC123037	12	30	37	87
MCBC123041	12	30	41	92
MCBC152429	15	24	29	69
MCBC152433	15	24	33	75
MCBC152435	15	24	35	78
MCBC152437	15	24	37	83
MCBC152441	15	24	41	88
MCBC153029	15	30	29	80
MCBC153033	15	30	33	87
MCBC153035	15	30	35	90
MCBC153037	15	30	37	96
MCBC153041	15	30	41	101
MCBC182429	18	24	29	77
MCBC182433	18	24	33	83
MCBC182435	18	24	35	86
MCBC182437	18	24	37	91
MCBC182441	18	24	41	96
MCBC183029	18	30	29	88
MCBC183033	18	30	33	95
MCBC183035	18	30	35	99
MCBC183037	18	30	37	105
MCBC183041	18	30	41	111
MCBC212429	21	24	29	84
MCBC212433	21	24	33	91
MCBC212435	21	24	35	94
MCBC212437	21	24	37	100
MCBC212441	21	24	41	105
MCBC213029	21	30	29	96
MCBC213033	21	30	33	104
MCBC213035	21	30	35	108
MCBC213037	21	30	37	115
MCBC213041	21	30	41	122
MCBC232429	23	24	29	84
MCBC232433	23	24	33	91
MCBC232435	23	24	35	94

Open and Adjustable Shelf

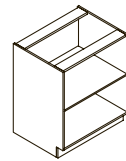

MCBD

MODEL #	WIDTH	DEPTH	HEIGHT	WEIGHT
MCBD122429	112	24	29	56
MCBD122433	12	24	33	61
MCBD122435	12	24	35	63
MCBD122437	12	24	37	67
MCBD122441	12	24	41	71
MCBD123029	12	30	29	66
MCBD123033	12	30	33	71
MCBD123035	12	30	35	74
MCBD123037	12	30	37	79
MCBD123041	12	30	41	83
MCBD152429	15	24	29	62
MCBD152433	15	24	33	67
MCBD152435	15	24	35	69
MCBD152437	15	24	37	73
MCBD152441	15	24	41	77
MCBD153029	15	30	29	72
MCBD153033	15	30	33	78
MCBD153035	15	30	35	81
MCBD153037	15	30	37	86
MCBD153041	15	30	41	91
MCBD182429	18	24	29	68
MCBD182433	18	24	33	73
MCBD182435	18	24	35	75
MCBD182437	18	24	37	79
MCBD182441	18	24	41	83
MCBD183029	18	30	29	79
MCBD183033	18	30	33	85
MCBD183035	18	30	35	88
MCBD183037	18	30	37	93
MCBD183041	18	30	41	98
MCBD242429	24	24	29	80
MCBD242433	24	24	33	85
MCBD242435	24	24	35	88
MCBD242437	24	24	37	93
MCBD242441	24	24	41	97
MCBD243029	24	30	29	93
MCBD243033	24	30	33	99
MCBD243035	24	30	35	102

Open and Adjustable Shelf (cont.)

MODEL #	WIDTH	DEPTH	HEIGHT	WEIGHT
MCBD243037	24	30	37	107
MCBD243041	24	30	41	112
MCBD302429	30	24	29	92
MCBD302433	30	24	33	98
MCBD302435	30	24	35	101
MCBD302437	30	24	37	106
MCBD302441	30	24	41	111
MCBD303029	30	30	29	106
MCBD303033	30	30	33	113
MCBD303035	30	30	35	116
MCBD303037	30	30	37	122
MCBD303041	30	30	41	127
MCBD362429	36	24	29	104
MCBD362433	36	24	33	110
MCBD362435	36	24	35	113
MCBD362437	36	24	37	118
MCBD362441	36	24	41	123
MCBD363029	36	30	29	120
MCBD363033	36	30	33	127
MCBD363035	36	30	35	131
MCBD363037	36	30	37	137
MCBD363041	36	30	41	143
MCBD422429	42	24	29	115
MCBD422433	42	24	33	122
MCBD422435	42	24	35	126
MCBD422437	42	24	37	132
MCBD422441	42	24	41	138
MCBD423029	42	30	29	133
MCBD423033	42	30	33	141
MCBD423035	42	30	35	145
MCBD423037	42	30	37	152
MCBD423041	42	30	41	158

No upcharge to modify dimensions.

Drawer, Doors and Adjustable Shelf

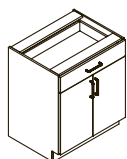

MCBE

MODEL #	WIDTH	DEPTH	HEIGHT	WEIGHT
MCBE242429	24	24	29	100
MCBE242433	24	24	33	107
MCBE242435	24	24	35	111
MCBE242437	24	24	37	117
MCBE242441	24	24	41	123
MCBE243029	24	30	29	113
MCBE243033	24	30	33	121
MCBE243035	24	30	35	125
MCBE243037	24	30	37	132
MCBE243041	24	30	41	138
MCBE302429	30	24	29	116
MCBE302433	30	24	33	125

Drawer, Doors and Adjustable Shelf (cont.)

MODEL #	WIDTH	DEPTH	HEIGHT	WEIGHT
MCBE302435	30	24	35	129
MCBE302437	30	24	37	136
MCBE302441	30	24	41	143
MCBE303029	30	30	29	131
MCBE303033	30	30	33	140
MCBE303035	30	30	35	144
MCBE303037	30	30	37	151
MCBE303041	30	30	41	158
MCBE362429	36	24	29	132
MCBE362433	36	24	33	142
MCBE362435	36	24	35	146
MCBE362437	36	24	37	154
MCBE362441	36	24	41	161
MCBE363029	36	30	29	148
MCBE363033	36	30	33	159
MCBE363035	36	30	35	164
MCBE363037	36	30	37	173
MCBE363041	36	30	41	182
MCBE422429	42	24	29	149
MCBE422433	42	24	33	159
MCBE422435	42	24	35	164
MCBE422437	42	24	37	173
MCBE422441	42	24	41	181
MCBE423029	42	30	29	166
MCBE423033	42	30	33	177
MCBE423035	42	30	35	183
MCBE423037	42	30	37	193
MCBE423041	42	30	41	202

No upcharge to modify dimensions.

Drawer, Left Door and Adjustable Shelf

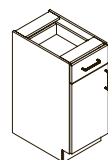

MCBF

MODEL #	WIDTH	DEPTH	HEIGHT	WEIGHT
MCBF122429	12	24	29	68
MCBF122433	12	24	33	73
MCBF122435	12	24	35	76
MCBF122437	12	24	37	81
MCBF122441	12	24	41	85
MCBF123029	12	30	29	77
MCBF123033	12	30	33	84
MCBF123035	12	30	35	87
MCBF123037	12	30	37	93
MCBF123041	12	30	41	98
MCBF152429	15	24	29	76
MCBF152433	15	24	33	82
MCBF152435	15	24	35	85
MCBF152437	15	24	37	90
MCBF152441	15	24	41	95
MCBF153029	15	30	29	86

Drawer, Left Door and Adjustable Shelf (cont.)

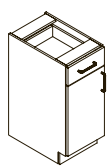

MODEL #	WIDTH	DEPTH	HEIGHT	WEIGHT
MCBF153033	15	30	33	93
MCBF153035	15	30	35	97
MCBF153037	15	30	37	103
MCBF153041	15	30	41	109
MCBF182429	18	24	29	84
MCBF182433	18	24	33	90
MCBF182435	18	24	35	94
MCBF182437	18	24	37	100
MCBF182441	18	24	41	105
MCBF183029	18	30	29	95
MCBF183033	18	30	33	103
MCBF183035	18	30	35	106
MCBF183037	18	30	37	112
MCBF183041	18	30	41	118
MCBF212429	21	24	29	92
MCBF212433	21	24	33	99
MCBF212435	21	24	35	102
MCBF212437	21	24	37	108
MCBF212441	21	24	41	113
MCBF213029	21	30	29	104
MCBF213033	21	30	33	112
MCBF213035	21	30	35	116
MCBF213037	21	30	37	123
MCBF213041	21	30	41	129
MCBF232429	23	24	29	92
MCBF232433	23	24	33	99
MCBF232435	23	24	35	102
MCBF232437	23	24	37	108
MCBF232441	23	24	41	113
MCBF233029	23	30	29	104
MCBF233033	23	30	33	112
MCBF233035	23	30	35	116
MCBF233037	23	30	37	123
MCBF233041	23	30	41	129

MCBF

No upcharge to modify dimensions.

Drawer, Right Door and Adjustable Shelf (cont.)

MODEL #	WIDTH	DEPTH	HEIGHT	WEIGHT
MCBG152433	15	24	33	82
MCBG152435	15	24	35	85
MCBG152437	15	24	37	90
MCBG152441	15	24	41	95
MCBG153029	15	30	29	86
MCBG153033	15	30	33	93
MCBG153035	15	30	35	97
MCBG123037	15	30	37	103
MCBG153041	15	30	41	109
MCBG182429	18	24	29	84
MCBG182433	18	24	33	90
MCBG182435	18	24	35	94
MCBG182437	18	24	37	100
MCBG182441	18	24	41	105
MCBG183029	18	30	29	95
MCBG183033	18	30	33	103
MCBG183035	18	30	35	106
MCBG183037	18	30	37	112
MCBG183041	18	30	41	118
MCBG212429	21	24	29	92
MCBG212433	21	24	33	99
MCBG212435	21	24	35	102
MCBG212437	21	24	37	108
MCBG212441	21	24	41	113
MCBG213029	21	30	29	104
MCBG213033	21	30	33	112
MCBG213035	21	30	35	116
MCBG213037	21	30	37	123
MCBG213041	21	30	41	129
MCBG232429	23	24	29	92
MCBG232433	23	24	33	99
MCBG232435	23	24	35	102
MCBG232437	23	24	37	108
MCBG232441	23	24	41	113
MCBG233029	23	30	29	104
MCBG233033	23	30	33	112
MCBG233035	23	30	35	116
MCBG233037	23	30	37	123
MCBG233041	23	30	41	129

No upcharge to modify dimensions.

Drawer, Right Door and Adjustable Shelf

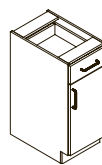

MODEL #	WIDTH	DEPTH	HEIGHT	WEIGHT
MCBG122429	12	24	29	68
MCBG122433	12	24	33	73
MCBG122435	12	24	35	76
MCBG122437	12	24	37	81
MCBG122441	12	24	41	85
MCBG123029	12	30	29	77
MCBG123033	12	30	33	84
MCBG123035	12	30	35	87
MCBG123037	12	30	37	93
MCBG123041	12	30	41	98
MCBG152429	15	24	29	76

MCBG

2 Drawers, Doors and Adjustable Shelf

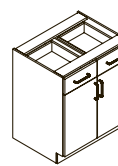

MODEL #	WIDTH	DEPTH	HEIGHT	WEIGHT
MCBH242429	24	24	29	106
MCBH242433	24	24	33	114
MCBH242435	24	24	35	118
MCBH242437	24	24	37	125
MCBH242441	24	24	41	131
MCBH243029	24	30	29	120

MCBH

2 Drawers, Doors and Adjustable Shelf (cont.)

MODEL #	WIDTH	DEPTH	HEIGHT	WEIGHT
MCBH243033	24	30	33	129
MCBH243035	24	30	35	133
MCBH243037	24	30	37	140
MCBH243041	24	30	41	147
MCBH302429	30	24	29	123
MCBH302433	30	24	33	131
MCBH302435	30	24	35	136
MCBH302437	30	24	37	143
MCBH302441	30	24	41	150
MCBH303029	30	30	29	138
MCBH303033	30	30	33	147
MCBH303035	30	30	35	152
MCBH303037	30	30	37	160
MCBH303041	30	30	41	167
MCBH362429	36	24	29	139
MCBH362433	36	24	33	148
MCBH362435	36	24	35	153
MCBH362437	36	24	37	161
MCBH362441	36	24	41	168
MCBH363029	36	30	29	155
MCBH363033	36	30	33	166
MCBH363035	36	30	35	172
MCBH363037	36	30	37	182
MCBH363041	36	30	41	191
MCBH422429	42	24	29	155
MCBH422433	42	24	33	165
MCBH422435	42	24	35	171
MCBH422437	42	24	37	180
MCBH422441	42	24	41	189
MCBH423029	42	30	29	173
MCBH423033	42	30	33	185
MCBH423035	42	30	35	191
MCBH423037	42	30	37	201
MCBH423041	42	30	41	211

No upcharge to modify dimensions.

Sink

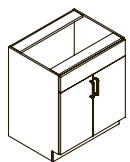

MCBI

MODEL #	WIDTH	DEPTH	HEIGHT	WEIGHT
MCBI242429	24	24	29	79
MCBI242433	24	24	33	86
MCBI242435	24	24	35	90
MCBI242437	24	24	37	97
MCBI242441	24	24	41	103
MCBI243029	24	30	29	88
MCBI243033	24	30	33	97
MCBI243035	24	30	35	101
MCBI243037	24	30	37	109
MCBI243041	24	30	41	116
MCBI302429	30	24	29	90

Sink (cont.)

MODEL #	WIDTH	DEPTH	HEIGHT	WEIGHT
MCBI302433	30	24	33	99
MCBI302435	30	24	35	103
MCBI302437	30	24	37	111
MCBI302441	30	24	41	118
MCBI303029	30	30	29	100
MCBI303033	30	30	33	110
MCBI303035	30	30	35	114
MCBI303037	30	30	37	122
MCBI303041	30	30	41	130
MCBI362429	36	24	29	102
MCBI362433	36	24	33	111
MCBI362435	36	24	35	116
MCBI362437	36	24	37	124
MCBI362441	36	24	41	132
MCBI363029	36	30	29	113
MCBI363033	36	30	33	123
MCBI363035	36	30	35	128
MCBI363037	36	30	37	137
MCBI363041	36	30	41	145
MCBI422429	42	24	29	113
MCBI422433	42	24	33	123
MCBI422435	42	24	35	128
MCBI422437	42	24	37	137
MCBI422441	42	24	41	145
MCBI423029	42	30	29	125
MCBI423033	42	30	33	136
MCBI423035	42	30	35	141
MCBI423037	42	30	37	150
MCBI423041	42	30	41	159

No upcharge to modify dimensions.

Sorter with 15 Shelves*



MCBK

MODEL #	WIDTH	DEPTH	HEIGHT	WEIGHT
MCBK362429	36	24	29	108
MCBK362433	36	24	33	117
MCBK362435	36	24	35	122
MCBK362437	36	24	37	130
MCBK362441	36	24	41	138
MCBK363029	36	30	29	123
MCBK363033	36	30	33	134
MCBK363035	36	30	35	139
MCBK363037	36	30	37	148
MCBK363041	36	30	41	157
MCBK422429	42	24	29	117
MCBK422433	42	24	33	126
MCBK422435	42	24	35	131
MCBK422437	42	24	37	135
MCBK422441	42	24	41	147
MCBK423029	42	30	29	132

Sorter with 15 Shelves* (cont.)

MODEL #	WIDTH	DEPTH	HEIGHT	WEIGHT
MCBK423033	42	30	33	143
MCBK423035	42	30	35	149
MCBK423037	42	30	37	159
MCBK423041	42	30	41	168

No upcharge to modify height and depth dimensions.
Shaded selections have oversize shelves; unshaded feature legal size shelves.

Sorter with Doors and 9 Shelves*



MCBL

MODEL #	WIDTH	DEPTH	HEIGHT	WEIGHT
MCBL362429	36	24	29	125
MCBL362433	36	24	33	134
MCBL362435	36	24	35	139
MCBL362437	36	24	37	147
MCBL362441	36	24	41	155
MCBL363029	36	30	29	143
MCBL363033	36	30	33	154
MCBL363035	36	30	35	159
MCBL363037	36	30	37	168
MCBL363041	36	30	41	177
MCBL422429	42	24	29	139
MCBL422433	42	24	33	148
MCBL422435	42	24	35	153
MCBL422437	42	24	37	161
MCBL422441	42	24	41	168
MCBL423029	42	30	29	158
MCBL423033	42	30	33	169
MCBL423035	42	30	35	175
MCBL423037	42	30	37	185
MCBL423041	42	30	41	194

No upcharge to modify height and depth dimensions.
Shaded selections have oversize shelves; unshaded feature legal size shelves.

Vertical Slot (cont.)

MODEL #	WIDTH	DEPTH	HEIGHT	WEIGHT
MCBM302435	30	24	35	158
MCBM302437	30	24	37	172
MCBM302441	30	24	41	186
MCBM303029	30	30	29	159
MCBM303033	30	30	33	179
MCBM303035	30	30	35	188
MCBM303037	30	30	37	205
MCBM303041	30	30	41	222
MCBM362429	36	24	29	154
MCBM362433	36	24	33	173
MCBM362435	36	24	35	182
MCBM362437	36	24	37	199
MCBM362441	36	24	41	215
MCBM363029	36	30	29	183
MCBM363033	36	30	33	205
MCBM363035	36	30	35	216
MCBM363037	36	30	37	236
MCBM363041	36	30	41	255
MCBM422429	42	24	29	174
MCBM422433	42	24	33	195
MCBM422435	42	24	35	206
MCBM422437	42	24	37	225
MCBM422441	42	24	41	244
MCBM423029	42	30	29	207
MCBM423033	42	30	33	232
MCBM423035	42	30	35	245
MCBM423037	42	30	37	268
MCBM423041	42	30	41	290

No upcharge to modify dimensions.
Dividers are fixed with approximate 3" openings.
24" width has 6 openings
30" width has 8 openings
36" width has 9 openings
42" width has 11 openings

Vertical Slot

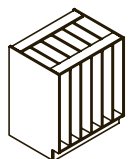

MCBM

MODEL #	WIDTH	DEPTH	HEIGHT	WEIGHT
MCBM242429	24	24	29	114
MCBM242433	24	24	33	127
MCBM242435	24	24	35	134
MCBM242437	24	24	37	146
MCBM242441	24	24	41	158
MCBM243029	24	30	29	135
MCBM243033	24	30	33	152
MCBM243035	24	30	35	160
MCBM243037	24	30	37	175
MCBM243041	24	30	41	190
MCBM302429	30	24	29	134
MCBM302433	30	24	33	150

ADA Sink

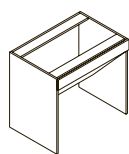

MCBN

MODEL #	WIDTH	DEPTH	HEIGHT	WEIGHT
MCBN332433	33	24	33	86
MCBN362433	36	24	33	90
MCBN422433	42	24	33	99

No upcharge to modify dimensions.

Corner with Doors

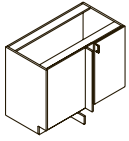

MCBO

See page 36 for ordering instructions.

MODEL #	WIDTH	DEPTH	HEIGHT	WEIGHT
MCBO462429	46	24	29	115
MCBO462433	46	24	33	125
MCBO462435	46	24	35	130
MCBO462437	46	24	37	138
MCBO462441	46	24	41	147
MCBO523029	52	30	29	137
MCBO523033	52	30	33	148
MCBO523035	52	30	35	154
MCBO523037	52	30	37	164
MCBO523041	52	30	41	173

No upcharge to modify dimensions.

Corner Open

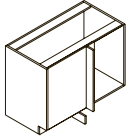

MCBP

See page 36 for ordering instructions.

MODEL #	WIDTH	DEPTH	HEIGHT	WEIGHT
MCBP462429	46	24	29	106
MCBP462433	46	24	33	114
MCBP462435	46	24	35	119
MCBP462437	46	24	37	127
MCBP462441	46	24	41	134
MCBP523029	52	30	29	128
MCBP523033	52	30	33	138
MCBP523035	52	30	35	143
MCBP523037	52	30	37	152
MCBP523041	52	30	41	160

No upcharge to modify dimensions.

Knee Space Open



MCBS

MODEL #	WIDTH	DEPTH	HEIGHT	WEIGHT
MCBS212429	21	24	29	62
MCBS212433	21	24	33	68
MCBS212435	21	24	35	72
MCBS212437	21	24	37	77
MCBS212441	21	24	41	82
MCBS213029	21	30	29	73
MCBS213033	21	30	33	81
MCBS213035	21	30	35	85
MCBS213037	21	30	37	92
MCBS213041	21	30	41	98
MCBS242429	24	24	29	66
MCBS242433	24	24	33	73
MCBS242435	24	24	35	76
MCBS242437	24	24	37	82
MCBS242441	24	24	41	87
MCBS243029	24	30	29	78
MCBS243033	24	30	33	86

Knee Space Open (cont.)

MODEL #	WIDTH	DEPTH	HEIGHT	WEIGHT
MCBS243035	24	30	35	90
MCBS243037	24	30	37	97
MCBS243041	24	30	41	103
MCBS302429	30	24	29	74
MCBS302433	30	24	33	81
MCBS302435	30	24	35	85
MCBS302437	30	24	37	91
MCBS302441	30	24	41	97
MCBS303029	30	30	29	87
MCBS303033	30	30	33	96
MCBS303035	30	30	35	100
MCBS303037	30	30	37	107
MCBS303041	30	30	41	114
MCBS362429	36	24	29	82
MCBS362433	36	24	33	90
MCBS362435	36	24	35	94
MCBS362437	36	24	37	101
MCBS362441	36	24	41	107
MCBS363029	36	30	29	96
MCBS363033	36	30	33	105
MCBS363035	36	30	35	110
MCBS363037	36	30	37	118
MCBS363041	36	30	41	125
MCBS422429	42	24	29	90
MCBS422433	42	24	33	99
MCBS422435	42	24	35	103
MCBS422437	42	24	37	110
MCBS422441	42	24	41	117
MCBS423029	42	30	29	105
MCBS423033	42	30	33	115
MCBS423035	42	30	35	120
MCBS423037	42	30	37	128
MCBS423041	42	30	41	135
MCBS482429	48	24	29	98
MCBS482433	48	24	33	107
MCBS482435	48	24	35	112
MCBS482437	48	24	37	120
MCBS482441	48	24	41	127
MCBS483029	48	30	29	114
MCBS483033	48	30	33	125
MCBS483035	48	30	35	130
MCBS483037	48	30	37	138
MCBS483041	48	30	41	146
MCBS542429	54	24	29	106
MCBS542433	54	24	33	116
MCBS542435	54	24	35	121
MCBS542437	54	24	37	129
MCBS542441	54	24	41	136
MCBS543029	54	30	29	123

Knee Space Open (cont.)

MODEL #	WIDTH	DEPTH	HEIGHT	WEIGHT
MCBS483033	48	30	33	125
MCBS483035	48	30	35	130
MCBS483037	48	30	37	138
MCBS483041	48	30	41	146
MCBS542429	54	24	29	106
MCBS542433	54	24	33	116
MCBS542435	54	24	35	121
MCBS542437	54	24	37	129
MCBS542441	54	24	41	136
MCBS543029	54	30	29	123
MCBS543033	54	30	33	134
MCBS543035	54	30	35	140
MCBS543037	54	30	37	149
MCBS543041	54	30	41	157
MCBS602429	60	24	29	114
MCBS602433	60	24	33	125
MCBS602435	60	24	35	130
MCBS602437	60	24	37	138
MCBS602441	60	24	41	146
MCBS603029	60	30	29	132
MCBS603033	60	30	33	144
MCBS603035	60	30	35	150
MCBS603037	60	30	37	159
MCBS603041	60	30	41	168

No upcharge to modify dimensions. Use price of the next larger item.

Tops are unfinished. Work surface purchased separately.

Units have full modesty panels. Reduced height and split modesty panels are available with no upcharge.

Sink Base Cabinet w/Rem False Front (cont.)

MODEL #	WIDTH	DEPTH	HEIGHT	WEIGHT
MCBT303029	30	30	29	104
MCBT303033	30	30	33	109
MCBT303035	30	30	35	120
MCBT303037	30	30	37	130
MCBT303041	30	30	41	149
MCBT362429	36	24	29	105
MCBT362433	36	24	33	111
MCBT362435	36	24	35	122
MCBT362437	36	24	37	133
MCBT362441	36	24	41	153
MCBT363029	36	30	29	116
MCBT363033	36	30	33	122
MCBT363035	36	30	35	134
MCBT363037	36	30	37	145
MCBT363041	36	30	41	167
MCBT422429	42	24	29	119
MCBT422433	42	24	33	125
MCBT422435	42	24	35	138
MCBT422437	42	24	37	150
MCBT422441	42	24	41	173
MCBT423029	42	30	29	131
MCBT423033	42	30	33	138
MCBT423035	42	30	35	152
MCBT423037	42	30	37	164
MCBT423041	42	30	41	188

No upcharge to modify dimensions.

Tops are unfinished. Work surface purchased separately.

Sink Base Cabinet w/Removable False Front

MCBT

MODEL #	WIDTH	DEPTH	HEIGHT	WEIGHT
MCBT242429	24	24	29	85
MCBT242433	24	24	33	89
MCBT242435	24	24	35	98
MCBT242437	24	24	37	106
MCBT242441	24	24	41	123
MCBT243029	24	30	29	93
MCBT243033	24	30	33	98
MCBT243035	24	30	35	108
MCBT243037	24	30	37	117
MCBT243041	24	30	41	135
MCBT302429	30	24	29	94
MCBT302433	30	24	33	99
MCBT302435	30	24	35	109
MCBT302437	30	24	37	118
MCBT302441	30	24	41	137

Recycling with Pivot

MCBU

MODEL #	WIDTH	DEPTH	HEIGHT	WEIGHT
MCBU152429	15	24	29	78
MCBU152433	15	24	33	84
MCBU152435	15	24	35	87
MCBU152437	15	24	37	92
MCBU152441	15	24	41	96
MCBU153029	15	30	29	91
MCBU153033	15	30	33	99
MCBU153035	15	30	35	102
MCBU153037	15	30	37	108
MCBU153041	15	30	41	114
MCBU182429	18	24	29	87
MCBU182433	18	24	33	93
MCBU182435	18	24	35	97
MCBU182437	18	24	37	102
MCBU182441	18	24	41	106

Recycling with Pivot (cont.)

MODEL #	WIDTH	DEPTH	HEIGHT	WEIGHT
MCBU183029	18	30	29	101
MCBU183033	18	30	33	109
MCBU183035	18	30	35	113
MCBU183037	18	30	37	119
MCBU183041	18	30	41	125
MCBU242429	24	24	29	105
MCBU242433	24	24	33	112
MCBU242435	24	24	35	116
MCBU242437	24	24	37	122
MCBU242441	24	24	41	127
MCBU243029	24	30	29	122
MCBU243033	24	30	33	130
MCBU243035	24	30	35	134
MCBU243037	24	30	37	141
MCBU243041	24	30	41	147
MCBU302429	30	24	29	124
MCBU302433	30	24	33	131
MCBU302435	30	24	35	135
MCBU302437	30	24	37	141
MCBU302441	30	24	41	147
MCBU303029	30	30	29	142
MCBU303033	30	30	33	151
MCBU303035	30	30	35	156
MCBU303037	30	30	37	154
MCBU303041	30	30	41	169

No upcharge to modify dimensions.

Tops are unfinished. Work surface purchased separately.

Recycling with Slide Out



MCBV

MODEL #	WIDTH	DEPTH	HEIGHT	WEIGHT
MCBV182429	18	24	29	120
MCBV182433	18	24	33	131
MCBV182435	18	24	35	136
MCBV182437	18	24	37	141
MCBV182441	18	24	41	151
MCBV183029	18	30	29	138
MCBV183033	18	30	33	150
MCBV183035	18	30	35	155
MCBV183037	18	30	37	161
MCBV183041	18	30	41	172
MCBV242429	24	24	29	146
MCBV242433	24	24	33	158
MCBV242435	24	24	35	164
MCBV242437	24	24	37	170

Recycling with Slide Out (cont.)

MODEL #	WIDTH	DEPTH	HEIGHT	WEIGHT
MCBV242441	24	24	41	182
MCBV243029	24	30	29	166
MCBV243033	24	30	33	179
MCBV243035	24	30	35	186
MCBV243037	24	30	37	193
MCBV243041	24	30	41	206

No upcharge to modify dimensions.
Tops are unfinished. Work surface purchased separately.

Corner Filter



MCBW

MODEL #	WIDTH	DEPTH	HEIGHT	WEIGHT
MCBW282829	28	28	29	75
MCBW282833	28	28	33	79
MCBW282835	28	28	35	82
MCBW282837	28	28	37	86
MCBW282841	28	28	41	90
MCBW343429	34	34	29	101
MCBW343433	34	34	33	107
MCBW343435	34	34	35	110
MCBW343437	34	34	37	115
MCBW343441	34	34	41	120

No upcharge to modify dimensions.
Tops are unfinished. Work surface purchased separately.

Open Corner Counter



MCBX

MODEL #	WIDTH	DEPTH	HEIGHT	WEIGHT
MCBX424229	42	42	29	129
MCBX424233	42	42	33	138
MCBX424235	42	42	35	143
MCBX424237	42	42	37	150
MCBX424241	42	42	41	156
MCBX484229	48	48	29	153
MCBX484233	48	48	33	164
MCBX484235	48	48	35	169
MCBX484237	48	48	37	177
MCBX484241	48	48	41	184

No upcharge to modify dimensions.
Work surface is included.



Two Drawer



MCDA

MODEL #	WIDTH	DEPTH	HEIGHT	WEIGHT
MCDA152429	15	24	29	88
MCDA152433	15	24	33	94
MCDA152435	15	24	35	97
MCDA152437	15	24	37	102
MCDA152441	15	24	41	107
MCDA153029	15	30	29	96
MCDA153033	15	30	33	103
MCDA153035	15	30	35	107
MCDA153037	15	30	37	113
MCDA153041	15	30	41	119
MCDA182429	18	24	29	97
MCDA182433	18	24	33	103
MCDA182435	18	24	35	106
MCDA182437	18	24	37	111
MCDA182441	18	24	41	116
MCDA183029	18	30	29	105
MCDA183033	18	30	33	113
MCDA183035	18	30	35	116
MCDA183037	18	30	37	122
MCDA183041	18	30	41	128
MCDA212429	21	24	29	105
MCDA212433	21	24	33	112
MCDA212435	21	24	35	115
MCDA212437	21	24	37	121
MCDA212441	21	24	41	126
MCDA213029	21	30	29	114
MCDA213033	21	30	33	122
MCDA213035	21	30	35	126
MCDA213037	21	30	37	133
MCDA213041	21	30	41	139
MCDA242429	24	24	29	113
MCDA242433	24	24	33	121
MCDA242435	24	24	35	124
MCDA242437	24	24	37	130
MCDA242441	24	24	41	136
MCDA243029	24	30	29	123
MCDA243033	24	30	33	131
MCDA243035	24	30	35	135
MCDA243037	24	30	37	142
MCDA243041	24	30	41	148
MCDA302429	30	24	29	130
MCDA302433	30	24	33	139
MCDA302435	30	24	35	143
MCDA302437	30	24	37	150
MCDA302441	30	24	41	157
MCDA303029	30	30	29	140
MCDA303033	30	30	33	150

Two Drawer (cont.)

MODEL #	WIDTH	DEPTH	HEIGHT	WEIGHT
MCDA303035	30	30	35	154
MCDA303037	30	30	37	162
MCDA303041	30	30	41	169
MCDA362429	36	24	29	147
MCDA362433	36	24	33	156
MCDA362435	36	24	35	161
MCDA362437	36	24	37	169
MCDA362441	36	24	41	176
MCDA363029	36	30	29	158
MCDA363033	36	30	33	168
MCDA363035	36	30	35	173
MCDA363037	36	30	37	181
MCDA363041	36	30	41	189
MCDA422429	42	24	29	164
MCDA422433	42	24	33	174
MCDA422435	42	24	35	179
MCDA422437	42	24	37	187
MCDA422441	42	24	41	195
MCDA423029	42	30	29	176
MCDA423033	42	30	33	187
MCDA423035	42	30	35	192
MCDA423037	42	30	37	201
MCDA423041	42	30	41	209

No upcharge to modify dimensions.

Drawers are evenly spaced and are not designed to hold hanging files. If hanging files are required, order the MCDI. Drawer heights may be modified. Configurations are available with upcharges between \$36 to \$146. Call for exact pricing.

Three Drawers



MCDB

MODEL #	WIDTH	DEPTH	HEIGHT	WEIGHT
MCDB152429	15	24	29	88
MCDB152433	15	24	33	94
MCDB152435	15	24	35	97
MCDB152437	15	24	37	102
MCDB152441	15	24	41	107
MCDB153029	15	30	29	96
MCDB153033	15	30	33	103
MCDB153035	15	30	35	107
MCBU153037	15	30	37	113
MCBU153041	15	30	41	119
MCBU182429	18	24	29	97

Three Drawers (cont.)

MODEL #	WIDTH	DEPTH	HEIGHT	WEIGHT
MCDB212433	21	24	33	112
MCDB212435	21	24	35	115
MCDB212437	21	24	37	121
MCDB212441	21	24	41	126
MCDB213029	21	30	29	114
MCDB213033	21	30	33	122
MCDB213035	21	30	35	126
MCDB213037	21	30	37	133
MCDB213041	21	30	41	139
MCDB242429	24	24	29	113
MCDB242433	24	24	33	121
MCDB242435	24	24	35	124
MCDB242437	24	24	37	130
MCDB242441	24	24	41	136
MCDB243029	24	30	29	123
MCDB243033	24	30	33	131
MCDB243035	24	30	35	135
MCDB243037	24	30	37	142
MCDB243041	24	30	41	148
MCDB302429	30	24	29	130
MCDB302433	30	24	33	139
MCDB302435	30	24	35	143
MCDB302437	30	24	37	150
MCDB302441	30	24	41	157
MCDB303029	30	30	29	140
MCDB303033	30	30	33	150
MCDB303035	30	30	35	154
MCDB303037	30	30	37	162
MCDB303041	30	30	41	169
MCDB362429	36	24	29	147
MCDB362433	36	24	33	156
MCDB362435	36	24	35	161
MCDB362437	36	24	37	169
MCDB362441	36	24	41	176
MCDB363029	36	30	29	158
MCDB363033	36	30	33	168
MCDB363035	36	30	35	173
MCDB363037	36	30	37	181
MCDB363041	36	30	41	189
MCDB422429	42	24	29	164
MCDB422433	42	24	33	174
MCDB422435	42	24	35	179
MCDB422437	42	24	37	187
MCDB422441	42	24	41	195
MCDB423029	42	30	29	176
MCDB423033	42	30	33	187
MCDB423035	42	30	35	192

Three Drawers (cont.)

MODEL #	WIDTH	DEPTH	HEIGHT	WEIGHT
MCDB423037	42	30	37	201
MCDB423041	42	30	41	209

No upcharge to modify dimensions.
Drawers are evenly spaced. Drawer heights may be modified.

Four Drawers



MCDC

MODEL #	WIDTH	DEPTH	HEIGHT	WEIGHT
MCDC152429	15	24	29	88
MCDC152433	15	24	33	94
MCDC152435	15	24	35	97
MCDC152437	15	24	37	102
MCDC152441	15	24	41	107
MCDC153029	15	30	29	96
MCDC153033	15	30	33	103
MCDC153035	15	30	35	107
MCDC153037	15	30	37	113
MCDC153041	15	30	41	119
MCDC182429	18	24	29	97
MCDC182433	18	24	33	103
MCDC182435	18	24	35	106
MCDC182437	18	24	37	111
MCDC182441	18	24	41	116
MCDC183029	18	30	29	105
MCDC183033	18	30	33	113
MCDC183035	18	30	35	116
MCDC183037	18	30	37	122
MCDC183041	18	30	41	128
MCDC212429	21	24	29	105
MCDC212433	21	24	33	112
MCDC212435	21	24	35	115
MCDC212437	21	24	37	121
MCDC212441	21	24	41	126
MCDC213029	21	30	29	114
MCDC213033	21	30	33	122
MCDC213035	21	30	35	126
MCDC213037	21	30	37	133
MCDC213041	21	30	41	139
MCDC242429	24	24	29	113
MCDC242433	24	24	33	121
MCDC242435	24	24	35	124
MCDC242437	24	24	37	130
MCDC242441	24	24	41	136
MCDC243029	24	30	29	123
MCDC243033	24	30	33	131
MCDC243035	24	30	35	135
MCDC243037	24	30	37	142
MCDC243041	24	30	41	148
MCDC302429	30	24	29	130

Four Drawers (cont.)

MODEL #	WIDTH	DEPTH	HEIGHT	WEIGHT
MCDC302433	30	24	33	139
MCDC302435	30	24	35	143
MCDC302437	30	24	37	150
MCDC302441	30	24	41	157
MCDC303029	30	30	29	140
MCDC303033	30	30	33	150
MCDC303035	30	30	35	154
MCDC303037	30	30	37	162
MCDC303041	30	30	41	169
MCDC362429	36	24	29	147
MCDC362433	36	24	33	156
MCDC362435	36	24	35	161
MCDC362437	36	24	37	169
MCDC362441	36	24	41	176
MCDC363029	36	30	29	158
MCDC363033	36	30	33	168
MCDC363035	36	30	35	173
MCDC363037	36	30	37	181
MCDC363041	36	30	41	189
MCDC422429	42	24	29	164
MCDC422433	42	24	33	174
MCDC422435	42	24	35	179
MCDC422437	42	24	37	187
MCDC422441	42	24	41	195
MCDC423029	42	30	29	176
MCDC423033	42	30	33	187
MCDC423035	42	30	35	192
MCDC423037	42	30	37	201

No upcharge to modify dimensions.

Drawers are evenly spaced. Drawer heights may be modified and additional drawers added up to a 7 drawer maximum.

Pharmacy Indexing Drawers



MCDD

MODEL #	WIDTH	DEPTH	HEIGHT	WEIGHT
MCDD242429	24	24	29	92
MCDD242433	24	24	33	99
MCDD242435	24	24	35	103
MCDD242437	24	24	37	108
MCDD242441	24	24	41	113
MCDD243029	24	30	29	104
MCDD243033	24	30	33	113
MCDD243035	24	30	35	117
MCDD243037	24	30	37	123
MCDD243041	24	30	41	129
MCDD302429	30	24	29	107
MCDD302433	30	24	33	114
MCDD302435	30	24	35	118
MCDD302437	30	24	37	124
MCDD302441	30	24	41	130
MCDD303029	30	30	29	120
MCDD303033	30	30	33	129
MCDD303035	30	30	35	133
MCDD303037	30	30	37	140
MCDD303041	30	30	41	147
MCDD362429	36	24	29	121
MCDD362433	36	24	33	130
MCDD362435	36	24	35	134
MCDD362437	36	24	37	141
MCDD362441	36	24	41	147
MCDD363029	36	30	29	136
MCDD363033	36	30	33	145
MCDD363035	36	30	35	150
MCDD363037	36	30	37	157
MCDD363041	36	30	41	164
MCDD422429	42	24	29	136
MCDD422433	42	24	33	145
MCDD422435	42	24	35	150
MCDD422437	42	24	37	157
MCDD422441	42	24	41	163
MCDD423029	42	30	29	151
MCDD423033	42	30	33	161
MCDD423035	42	30	35	166
MCDD423037	42	30	37	174
MCDD423041	42	30	41	182

No upcharge to modify dimensions.

Indexing drawers include card follower/track designed to hold indexing cards to front of drawer.

Pharmacy Bottle Drawers



MCDE

MODEL #	WIDTH	DEPTH	HEIGHT	WEIGHT
MCDE242429	24	24	29	132
MCDE242433	24	24	33	139
MCDE242435	24	24	35	142
MCDE242437	24	24	37	148
MCDE242441	24	24	41	153
MCDE243029	24	30	29	157
MCDE243033	24	30	33	166
MCDE243035	24	30	35	170
MCDE243037	24	30	37	176
MCDE243041	24	30	41	182
MCDE302429	30	24	29	157
MCDE302433	30	24	33	165
MCDE302435	30	24	35	169
MCDE302437	30	24	37	175
MCDE302441	30	24	41	181
MCDE303029	30	30	29	187
MCDE303033	30	30	33	196
MCDE303035	30	30	35	201
MCDE303037	30	30	37	208
MCDE303041	30	30	41	214
MCDE362429	36	24	29	183
MCDE362433	36	24	33	191
MCDE362435	36	24	35	195
MCDE362437	36	24	37	202
MCDE362441	36	24	41	208
MCDE363029	36	30	29	217
MCDE363033	36	30	33	227
MCDE363035	36	30	35	232
MCDE363037	36	30	37	239
MCDE363041	36	30	41	246
MCDE422429	42	24	29	208
MCDE422433	42	24	33	217
MCDE422435	42	24	35	222
MCDE422437	42	24	37	229
MCDE422441	42	24	41	235
MCDE423029	42	30	29	247
MCDE423033	42	30	33	257
MCDE423035	42	30	35	263
MCDE423037	42	30	37	271
MCDE423041	42	30	41	278

No upcharge to modify dimensions.

Top two drawers are designed on an angle and include (3) dividers. The bottom drawer is flat.

Pharmacy Tray Drawers



MCDF

MODEL #	WIDTH	DEPTH	HEIGHT	WEIGHT
MCDF122429	12	24	29	93
MCDF122433	12	24	33	100
MCDF122435	12	24	35	103
MCDF122437	12	24	37	108
MCDF122441	12	24	41	112
MCDF123029	12	30	29	112
MCDF123033	12	30	33	120
MCDF123035	12	30	35	123
MCDF123037	12	30	37	129
MCDF123041	12	30	41	135
MCDF152429	15	24	29	93
MCDF152433	15	24	33	100
MCDF152435	15	24	35	103
MCDF152437	15	24	37	108
MCDF152441	15	24	41	112
MCDF153029	15	30	29	112
MCDF153033	15	30	33	120
MCDF153035	15	30	35	123
MCDF153037	15	30	37	129
MCDF153041	15	30	41	135
MCDF182429	18	24	29	106
MCDF182433	18	24	33	113
MCDF182435	18	24	35	116
MCDF182437	18	24	37	121
MCDF182441	18	24	41	126
MCDF183029	18	30	29	127
MCDF183033	18	30	33	135
MCDF183035	18	30	35	139
MCDF183037	18	30	37	145
MCDF183041	18	30	41	151
MCDF242429	24	24	29	132
MCDF242433	24	24	33	139
MCDF242435	24	24	35	142
MCDF242437	24	24	37	148
MCDF242441	24	24	41	153
MCDF243029	24	30	29	157
MCDF243033	24	30	33	166
MCDF243035	24	30	35	170
MCDF243037	24	30	37	176
MCDF243041	24	30	41	182
MCDF302429	30	24	29	157
MCDF302433	30	24	33	165
MCDF302435	30	24	35	169
MCDF302437	30	24	37	175
MCDF302441	30	24	41	181
MCDF303029	30	30	29	187
MCDF303033	30	30	33	196
MCDF303035	30	30	35	201
MCDF303037	30	30	37	208

Pharmacy Tray Drawers (cont.)

MODEL #	WIDTH	DEPTH	HEIGHT	WEIGHT
MCDF303041	30	30	41	214
MCDF362429	36	24	29	183
MCDF362433	36	24	33	191
MCDF362435	36	24	35	195
MCDF362437	36	24	37	202
MCDF362441	36	24	41	208
MCDF363029	36	30	29	217
MCDF363033	36	30	33	227
MCDF363035	36	30	35	232
MCDF363037	36	30	37	239
MCDF363041	36	30	41	246

No upcharge to modify dimensions.

Drawers are 4" high flat drawers with (4) dividers creating 9 sections.

Slide Out Shelves (cont.)

MODEL #	WIDTH	DEPTH	HEIGHT	WEIGHT
MCDG242435	24	24	35	142
MCDG242437	24	24	37	148
MCDG242441	24	24	41	153
MCDG243029	24	30	29	157
MCDG243033	24	30	33	166
MCDG243035	24	30	35	170
MCDG243037	24	30	37	176
MCDG243041	24	30	41	182
MCDG302429	30	24	29	157
MCDG302433	30	24	33	165
MCDG302435	30	24	35	169
MCDG302437	30	24	37	175
MCDG302441	30	24	41	181
MCDG303029	30	30	29	187
MCDG303033	30	30	33	196
MCDG303035	30	30	35	201
MCDG303037	30	30	37	208
MCDG303041	30	30	41	214
MCDG362429	36	24	29	183
MCDG362433	36	24	33	191
MCDG362435	36	24	35	195
MCDG362437	36	24	37	202
MCDG362441	36	24	41	208
MCDG363029	36	30	29	217
MCDG363033	36	30	33	227
MCDG363035	36	30	35	232
MCDG363037	36	30	37	239
MCDG363041	36	30	41	246

No upcharge to modify dimensions.

Shelves are 3" high flat shelves for easy access of printers and other devices.

Slide Out Shelves

MCDG

MODEL #	WIDTH	DEPTH	HEIGHT	WEIGHT
MCDG152429	15	24	29	93
MCDG152433	15	24	33	100
MCDG152435	15	24	35	103
MCDG152437	15	24	37	108
MCDG152441	15	24	41	112
MCDG153029	15	30	29	112
MCDG153033	15	30	33	120
MCDG153035	15	30	35	123
MCDG153037	15	30	37	129
MCDG153041	15	30	41	135
MCDG182429	18	24	29	106
MCDG182433	18	24	33	113
MCDG182435	18	24	35	116
MCDG182437	18	24	37	121
MCDG182441	18	24	41	126
MCDG183029	18	30	29	127
MCDG183033	18	30	33	135
MCDG183035	18	30	35	139
MCDG183037	18	30	37	145
MCDG183041	18	30	41	151
MCDG242429	24	24	29	132
MCDG242433	24	24	33	139

Box Box File



MCDH

MODEL #	WIDTH	DEPTH	HEIGHT	WEIGHT
MCDH152429	15	24	29	72
MCDH152433	15	24	33	82
MCDH152435	15	24	35	88
MCDH152437	15	24	37	96
MCDH152441	15	24	41	103
MCDH153029	15	30	29	83
MCDH153033	15	30	33	95
MCDH153035	15	30	35	100
MCDH153037	15	30	37	109
MCDH153041	15	30	41	118
MCDH182429	18	24	29	79
MCDH182433	18	24	33	91
MCDH182435	18	24	35	97
MCDH182437	18	24	37	106
MCDH182441	18	24	41	114
MCDH183029	18	30	29	91
MCDH183033	18	30	33	103
MCDH183035	18	30	35	110
MCDH183037	18	30	37	120
MCDH183041	18	30	41	129
MCDH242429	24	24	29	94
MCDH242433	24	24	33	108
MCDH242435	24	24	35	115
MCDH242437	24	24	37	125
MCDH242441	24	24	41	135
MCDH243029	24	30	29	106
MCDH243033	24	30	33	121
MCDH243035	24	30	35	129
MCDH243037	24	30	37	140
MCDH243041	24	30	41	151
MCDH302429	30	24	29	108
MCDH302433	30	24	33	124
MCDH302435	30	24	35	132
MCDH302437	30	24	37	145
MCDH302441	30	24	41	157
MCDH303029	30	30	29	121
MCDH303033	30	30	33	139
MCDH303035	30	30	35	147
MCDH303037	30	30	37	161
MCDH303041	30	30	41	174

No upcharge to modify dimensions.
 Bottom drawer is designed for hanging files and to hold a standard pendaflex folder.
 A 37"H unit has a Box File File.

File File



MCDI

MODEL #	WIDTH	DEPTH	HEIGHT	WEIGHT
MCDI152429	15	24	29	71
MCDI152433	15	24	33	80
MCDI152435	15	24	35	85
MCDI152437	15	24	37	92
MCDI152441	15	24	41	99
MCDI153029	15	30	29	82
MCDI153033	15	30	33	92
MCDI153035	15	30	35	97
MCDI153037	15	30	37	105
MCDI153041	15	30	41	113
MCDI182429	18	24	29	77
MCDI182433	18	24	33	88
MCDI182435	18	24	35	93
MCDI182437	18	24	37	101
MCDI182441	18	24	41	108
MCDI183029	18	30	29	89
MCDI183033	18	30	33	100
MCDI183035	18	30	35	106
MCDI183037	18	30	37	115
MCDI183041	18	30	41	123
MCDI242429	24	24	29	91
MCDI242433	24	24	33	103
MCDI242435	24	24	35	109
MCDI242437	24	24	37	118
MCDI242441	24	24	41	127
MCDI243029	24	30	29	103
MCDI243033	24	30	33	116
MCDI243035	24	30	35	123
MCDI243037	24	30	37	140
MCDI243041	24	30	41	143
MCDI302429	30	24	29	104
MCDI302433	30	24	33	118
MCDI302435	30	24	35	125
MCDI302437	30	24	37	136
MCDI302441	30	24	41	146
MCDI303029	30	30	29	117
MCDI303033	30	30	33	132
MCDI303035	30	30	35	140
MCDI303037	30	30	37	151
MCDI303041	30	30	41	162

No upcharge to modify dimensions.
 Both drawers are designed for hanging files and to hold a standard pendaflex folder.

Storage Cabinets

How to Specify Your Options

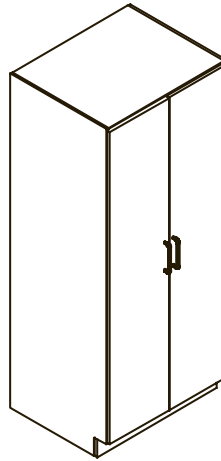

Door Front Options	
Model	Materials
LAM	Laminate
TFH	Thermofoil Harper
TFC	Thermofoil Celadon
TFP	Thermofoil Pavilion
FAC	Thermofoil/Acrylic-clear
FAF	Thermofoil/Acrylic-frosted
FGC	Thermofoil/Glass-clear
FGF	Thermofoil/Glass-frosted
AAC	Alum/Acrylic/clear
AAF	Alum/Acrylic-frosted
AGC	Alum/Glass-clear
AGF	Alum/Glass-frosted

Handle Options		
Model	Description	
EL	Elliptical Black	007B
ES	Elliptical Silver	001A
CB	Crescent Black	007A
CS	Crescent Silver	117A
TC	Textured Crescent	100A
FC	Flared Crescent	101A
RS	Recessed Silver	999
WP	Wired Pull	102A
BS	6" Bar Handle	103A
BE	8" Bar Handle	104A
BT	10" Bar Handle	105A

Door Lock Options	
Model	Description
Y	Locking doors
N	No locks

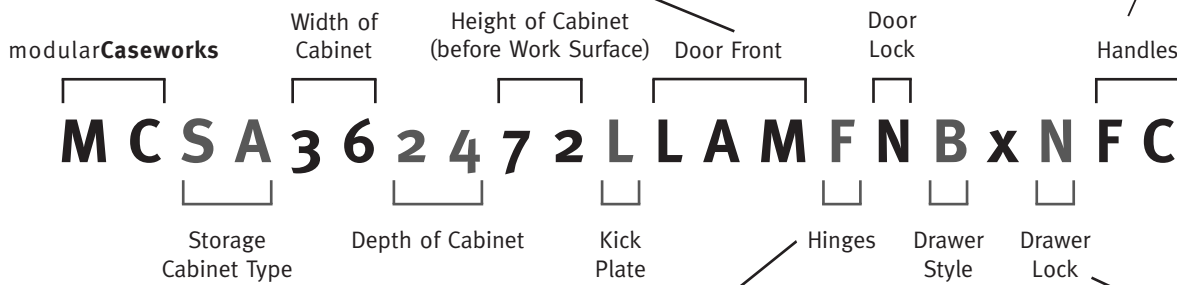

Kick Plate Options	
Model	Description
L	Laminate
P	Powder coated steel
S	Stainless steel
M	Laminate w/panel attachment
Q	Powder coat w/panel attachment
T	Stainless steel w/panel attachment

Drawer Lock Options	
Model	Description
Y	Locking drawers
N	No locks

Hinge Options	
Model	Description
O	Overlay 110 degree
S	110 degree soft close
F	270 degree
K	5 knuckle

Drawer Options	
Model	Description
B	Ball Bearing Slide*
R	Nylon Roller Slide*
U	Under Mount Slide*
C	Under Mount Slide with soft close*
M	Moovit Drawer System**

*White vinyl wrap
**Metal sides

Angled Top Option	
Model	Description
A	Sloped top

Change 2nd letter to A
Example: MCSB becomes MASB
Actual top purchased separately.

Storage Cabinet Products

With Doors, Fixed and Adjustable Shelves*

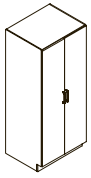

MCSA

MODEL #	WIDTH	DEPTH	HEIGHT	WEIGHT
MCSA241860	24	18	60	149
MCSA241866	24	18	66	159
MCSA241872	24	18	72	178
MCSA241884	24	18	84	197
MCSA242460	24	24	60	179
MCSA242466	24	24	66	190
MCSA242472	24	24	72	213
MCSA242484	24	24	84	235
MCSA243060	24	30	60	208
MCSA243066	24	30	66	221
MCSA243072	24	30	72	249
MCSA243084	24	30	84	274
MCSA301860	30	18	60	175
MCSA301866	30	18	66	186
MCSA301872	30	18	72	209
MCSA301884	30	18	84	231
MCSA302460	30	24	60	209
MCSA302466	30	24	66	221
MCSA302472	30	24	72	250
MCSA302484	30	24	84	274
MCSA303060	30	30	60	243
MCSA303066	30	30	66	256
MCSA303072	30	30	72	290
MCSA303084	30	30	84	318
MCSA361860	36	18	60	201
MCSA361866	36	18	66	214
MCSA361872	36	18	72	240
MCSA361884	36	18	84	265
MCSA362460	36	24	60	239
MCSA362466	36	24	66	253
MCSA362472	36	24	72	286
MCSA362484	36	24	84	314
MCSA363060	36	30	60	277
MCSA363066	36	30	66	292
MCSA363072	36	30	72	332
MCSA363084	36	30	84	362

No upcharge to modify dimensions. Use price of the next larger item.

*Shaded selections come standard with 1 fixed and 3 adjustable shelves; unshaded selections have 1 fixed and 2 adjustable shelves. Special configurations available. Call for pricing.

All units come with 1 adjustable coat rod.

Door Left and Adjustable Shelves*

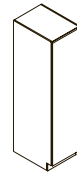

MCSB

MODEL #	WIDTH	DEPTH	HEIGHT	WEIGHT
MCSB181860	18	18	60	123
MCSB181866	18	18	66	132
MCSB181872	18	18	72	146
MCSB181884	18	18	84	163
MCSB182460	18	24	60	149
MCSB182466	18	24	66	158
MCSB182472	18	24	72	177
MCSB182484	18	24	84	196
MCSB183060	18	30	60	174
MCSB183066	18	30	66	185
MCSB183072	18	30	72	208
MCSB183084	18	30	84	230
MCSB231860	23	18	60	153
MCSB231866	23	18	66	163
MCSB231872	23	18	72	178
MCSB231884	23	18	84	202
MCSB232460	23	24	60	181
MCSB232466	23	24	66	195
MCSB232472	23	24	72	209
MCSB232484	23	24	84	238
MCSB233060	23	30	60	209
MCSB233066	23	30	66	225
MCSB233072	23	30	72	241
MCSB233084	23	30	84	273

No upcharge to modify dimensions. Use price of the next larger item.

*Shaded selections have 4 adjustable shelves; unshaded selections have 3 adjustable shelves.

All units come with 1 adjustable coat rod.

Door Right and Adjustable Shelves*



MCSC

MODEL #	WIDTH	DEPTH	HEIGHT	WEIGHT
MCSC181860	18	18	60	123
MCSC181866	18	18	66	132
MCSC181872	18	18	72	146
MCSC181884	18	18	84	163
MCSC182460	18	24	60	149
MCSC182466	18	24	66	158
MCSC182472	18	24	72	177
MCSC182484	18	24	84	196
MCSC183060	18	30	60	174
MCSC183066	18	30	66	185
MCSC183072	18	30	72	208
MCSC183084	18	30	84	230
MCSC231860	23	18	60	153
MCSC231866	23	18	66	163
MCSC231872	23	18	72	178

Door Right and Adjustable Shelves* (cont.)

MODEL #	WIDTH	DEPTH	HEIGHT	WEIGHT
MCSC231884	23	18	84	202
MCSC232460	23	24	60	181
MCSC232466	23	24	66	195
MCSC232472	23	24	72	209
MCSC232484	23	24	84	238
MCSC233060	23	30	60	209
MCSC233066	23	30	66	225
MCSC233072	23	30	72	241
MCSC233084	23	30	84	273

No upcharge to modify dimensions.

*Shaded selections have 4 adjustable shelves;
unshaded selections have 3 adjustable shelves.

All units come with 1 adjustable coat rod.

Wardrobe with Doors and 1 Drawer*

MCSK

MODEL #	WIDTH	DEPTH	HEIGHT	WEIGHT
MCSK242460	24	24	60	219
MCSK242466	24	24	66	230
MCSK242472	24	24	72	253
MCSK242484	24	24	84	275
MCSK243060	24	30	60	248
MCSK243066	24	30	66	261
MCSK243072	24	30	72	289
MCSK243084	24	30	84	314
MCSK302460	30	24	60	249
MCSK302466	30	24	66	261
MCSK302472	30	24	72	290
MCSK302484	30	24	84	314
MCSK303060	30	30	60	283
MCSK303066	30	30	66	296
MCSK303072	30	30	72	330
MCSK303084	30	30	84	358
MCSK362460	36	24	60	279
MCSK362466	36	24	66	293
MCSK362472	36	24	72	340
MCSK362484	36	24	84	354
MCSK363060	36	30	60	317
MCSK363066	36	30	66	332
MCSK363072	36	30	72	372
MCSK363084	36	30	84	402

No upcharge to modify dimensions.

Wardrobes have center partition with 2 adjustable shelves on one side and coat rod on the other. Special configurations available.

Wardrobe with Doors and 2 Drawers*

MCSL

MODEL #	WIDTH	DEPTH	HEIGHT	WEIGHT
MCSL242460	24	24	60	234
MCSL242466	24	24	66	245
MCSL242472	24	24	72	268
MCSL242484	24	24	84	290
MCSL243060	24	30	60	263
MCSL243066	24	30	66	276
MCSL243072	24	30	72	304
MCSL243084	24	30	84	329
MCSL302460	30	24	60	264
MCSL302466	30	24	66	276
MCSL302472	30	24	72	305
MCSL302484	30	24	84	329
MCSL303060	30	30	60	298
MCSL303066	30	30	66	311
MCSL303072	30	30	72	345
MCSL303084	30	30	84	373
MCSL362460	36	24	60	294
MCSL362466	36	24	66	308
MCSL362472	36	24	72	355
MCSL362484	36	24	84	369
MCSL363060	36	30	60	332
MCSL363066	36	30	66	347
MCSL363072	36	30	72	387
MCSL363084	36	30	84	417

No upcharge to modify dimensions.

Wardrobes have center partition with 2 adjustable shelves on one side and coat rod on the other. Special configurations available.

Open with Adjustable Shelves*

MCSD

MODEL #	WIDTH	DEPTH	HEIGHT	WEIGHT
MCSD181860	18	18	60	104
MCSD181866	18	18	66	110
MCSD181872	18	18	72	123
MCSD181884	18	18	84	135
MCSD182460	18	24	60	129
MCSD182466	18	24	66	137
MCSD182472	18	24	72	153
MCSD182484	18	24	84	168
MCSD183060	18	30	60	154
MCSD183066	18	30	66	163
MCSD183072	18	30	72	184
MCSD183084	18	30	84	202
MCSD241860	24	18	60	123
MCSD241866	24	18	66	130
MCSD241872	24	18	72	146
MCSD241884	24	18	84	160
MCSD242460	24	24	60	153

Open with Adjustable Shelves* (cont.)

MODEL #	WIDTH	DEPTH	HEIGHT	WEIGHT
MCSD242466	24	24	66	161
MCSD242472	24	24	72	182
MCSD242484	24	24	84	198
MCSD243060	24	30	60	182
MCSD243066	24	30	66	192
MCSD243072	24	30	72	217
MCSD243084	24	30	84	237
MCSD301860	30	18	60	143
MCSD301866	30	18	66	150
MCSD301872	30	18	72	169
MCSD301884	30	18	84	184
MCSD302460	30	24	60	176
MCSD302466	30	24	66	185
MCSD302472	30	24	72	210
MCSD302484	30	24	84	228
MCSD303060	30	30	60	210
MCSD303066	30	30	66	220
MCSD303072	30	30	72	251
MCSD303084	30	30	84	271
MCSD361860	36	18	60	162
MCSD361866	36	18	66	170
MCSD361872	36	18	72	192
MCSD361884	36	18	84	209
MCSD362460	36	24	60	200
MCSD362466	36	24	66	210
MCSD362472	36	24	72	238
MCSD362484	36	24	84	256
MCSD363060	36	30	60	238
MCSD363066	36	30	66	249
MCSD363072	36	30	72	284
MCSD363084	36	30	84	306

No upcharge to modify dimensions.

*Shaded selections come standard with 4 adjustable shelves; unshaded selections have 3 adjustable shelves. Special configurations available.

Locker with 4 Locking Left Doors

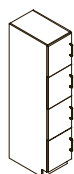

MCSE

MODEL #	WIDTH	DEPTH	HEIGHT	WEIGHT
MCSE121860	12	18	60	97
MCSE121866	12	18	66	104
MCSE121872	12	18	72	111
MCSE121884	12	18	84	125
MCSE122460	12	24	60	119
MCSE122466	12	24	66	127
MCSE122472	12	24	72	135
MCSE122484	12	24	84	151
MCSE123060	12	30	60	140

Locker with 4 Locking Left Doors (cont.)

MODEL #	WIDTH	DEPTH	HEIGHT	WEIGHT
MCSE123066	12	30	66	149
MCSE123072	12	30	72	159
MCSE123084	12	30	84	179
MCSE151860	15	18	60	110
MCSE151866	15	18	66	118
MCSE151872	15	18	72	125
MCSE151884	15	18	84	140
MCSE152460	15	24	60	134
MCSE152466	15	24	66	142
MCSE152472	15	24	72	151
MCSE152484	15	24	84	169
MCSE153060	15	30	60	157
MCSE153066	15	30	66	167
MCSE153072	15	30	72	178
MCSE153084	15	30	84	198
MCSE181860	18	18	60	123
MCSE181866	18	18	66	132
MCSE181872	18	18	72	140
MCSE181884	18	18	84	156
MCSE182460	18	24	60	149
MCSE182466	18	24	66	158
MCSE182472	18	24	72	168
MCSE182484	18	24	84	187
MCSE183060	18	30	60	174
MCSE183066	18	30	66	185
MCSE183072	18	30	72	196
MCSE183084	18	30	84	218

No upcharge to modify dimensions.

Locker heights are evenly spaced. Locker heights can be modified and up to 7 locker high configurations.

Special locking mechanisms available.

Locker with 4 Locking Right Doors



MCSF

MODEL #	WIDTH	DEPTH	HEIGHT	WEIGHT
MCSF121860	12	18	60	97
MCSF121866	12	18	66	104
MCSF121872	12	18	72	111
MCSF121884	12	18	84	125
MCSF122460	12	24	60	119
MCSF122466	12	24	66	127
MCSF122472	12	24	72	135
MCSF122484	12	24	84	151
MCSF123060	12	30	60	140
MCSF123066	12	30	66	149
MCSF123072	12	30	72	159
MCSF123084	12	30	84	179
MCSF151860	15	18	60	110

Locker with 4 Locking Right Doors (cont.)

MODEL #	WIDTH	DEPTH	HEIGHT	WEIGHT
MCSF151866	15	18	66	118
MCSF151872	15	18	72	125
MCSF151884	15	18	84	140
MCSF152460	15	24	60	134
MCSF152466	15	24	66	142
MCSF152472	15	24	72	151
MCSF152484	15	24	84	169
MCSF153060	15	30	60	157
MCSF153066	15	30	66	167
MCSF153072	15	30	72	178
MCSF153084	15	30	84	198
MCSF181860	18	18	60	123
MCSF181866	18	18	66	132
MCSF181872	18	18	72	140
MCSF181884	18	18	84	156
MCSF182460	18	24	60	149
MCSF182466	18	24	66	158
MCSF182472	18	24	72	168
MCSF182484	18	24	84	187
MCSF183060	18	30	60	174
MCSF183066	18	30	66	185
MCSF183072	18	30	72	196
MCSF183084	18	30	84	218

No upcharge to modify dimensions.

Locker heights are evenly spaced. Locker heights can be modified and up to 7 locker high configurations are available.

Special locking mechanisms available.

Locker with 2 Locking Left Doors

MCSI

MODEL #	WIDTH	DEPTH	HEIGHT	WEIGHT
MCSI121860	12	18	60	97
MCSI121866	12	18	66	104
MCSI121872	12	18	72	111
MCSI121884	12	18	84	125
MCSI122460	12	24	60	119
MCSI122466	12	24	66	127
MCSI122472	12	24	72	135
MCSI122484	12	24	84	151
MCSI123060	12	30	60	140
MCSI123066	12	30	66	149
MCSI123072	12	30	72	159
MCSI123084	12	30	84	179
MCSI151860	15	18	60	110
MCSI151866	15	18	66	118
MCSI151872	15	18	72	125
MCSI151884	15	18	84	140
MCSI152460	15	24	60	134
MCSI152466	15	24	66	142

Locker with 2 Locking Left Doors (cont.)

MODEL #	WIDTH	DEPTH	HEIGHT	WEIGHT
MCSI152460	15	24	60	134
MCSI152466	15	24	66	142
MCSI152472	15	24	72	151
MCSI152484	15	24	84	169
MCSI153060	15	30	60	157
MCSI153066	15	30	66	167
MCSI153072	15	30	72	178
MCSI153084	15	30	84	198
MCSI181860	18	18	60	123
MCSI181866	18	18	66	132
MCSI181872	18	18	72	140
MCSI181884	18	18	84	156
MCSI182460	18	24	60	149
MCSI182466	18	24	66	158
MCSI182472	18	24	72	168
MCSI182484	18	24	84	187
MCSI183060	18	30	60	174
MCSI183066	18	30	66	185
MCSI183072	18	30	72	196
MCSI183084	18	30	84	218

No upcharge to modify dimensions.

Locker heights are evenly spaced. Locker heights can be modified and up to 7 locker high configurations are available.

Special locking mechanisms and Z style doors available.

Locker with 2 Locking Right Doors

MCSJ

MODEL #	WIDTH	DEPTH	HEIGHT	WEIGHT
MCSJ121860	12	18	60	97
MCSJ121866	12	18	66	104
MCSJ121872	12	18	72	111
MCSJ121884	12	18	84	125
MCSJ122460	12	24	60	119
MCSJ122466	12	24	66	127
MCSJ122472	12	24	72	135
MCSJ122484	12	24	84	151
MCSJ123060	12	30	60	140
MCSJ123066	12	30	66	149
MCSJ123072	12	30	72	159
MCSJ123084	12	30	84	179
MCSJ151860	15	18	60	110
MCSJ151866	15	18	66	118
MCSJ151872	15	18	72	125
MCSJ151884	15	18	84	140
MCSJ152460	15	24	60	134
MCSJ152466	15	24	66	142

Locker with 2 Locking Right Doors (cont.)

MODEL #	WIDTH	DEPTH	HEIGHT	WEIGHT
MCSJ152472	15	24	72	151
MCSJ152484	15	24	84	169
MCSJ153060	15	30	60	157
MCSJ153066	15	30	66	167
MCSJ153072	15	30	72	178
MCSJ153084	15	30	84	198
MCSJ181860	18	18	60	123
MCSJ181866	18	18	66	132
MCSJ181872	18	18	72	140
MCSJ181884	18	18	84	156
MCSJ182460	18	24	60	149
MCSJ182466	18	24	66	158
MCSJ182472	18	24	72	168
MCSJ182484	18	24	84	187
MCSJ183060	18	30	60	174
MCSJ183066	18	30	66	185
MCSJ183072	18	30	72	196
MCSJ183084	18	30	84	218

No upcharge to modify dimensions.

Locker heights are evenly spaced. Locker heights can be modified and up to 7 locker high configurations are available.

Special locking mechanisms and Z style doors available.

Rolled Plan with 30 Fixed Openings*

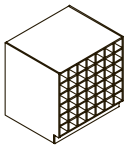

MODEL #	WIDTH	DEPTH	HEIGHT	WEIGHT
MCSG363035	36	30	35	236
MCSG363635	36	36	35	277

No upcharge to modify dimensions. Use price of the next larger item.

MCSG 30 Fixed openings (5 high 6 across) approximately 5" x 5".

Special configurations available upon request.

Vertical with 6 Fixed Openings*

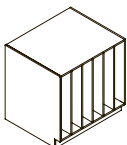

MODEL #	WIDTH	DEPTH	HEIGHT	WEIGHT
MCSH363035	36	30	35	200
MCSH363635	36	36	35	233

No upcharge to modify dimensions. Use price of the next larger item.

MCSH Special configurations available upon request.

Two Drawers with Top



MCSQ

MODEL #	WIDTH	DEPTH	HEIGHT	WEIGHT
MCSQ151830	15	18	30	68
MCSQ151834	15	18	34	75
MCSQ151836	15	18	36	78
MCSQ151842	15	18	42	88
MCSQ152430	15	24	30	83
MCSQ152434	15	24	34	91
MCSQ152436	15	24	36	94
MCSQ152442	15	24	42	106
MCSQ181830	18	18	30	78
MCSQ181834	18	18	34	85
MCSQ181836	18	18	36	89
MCSQ181842	18	18	42	96
MCSQ182430	18	24	30	94
MCSQ182434	18	24	34	102
MCSQ182436	18	24	36	106
MCSQ182442	18	24	42	119
MCSQ211830	21	18	30	88
MCSQ211834	21	18	34	95
MCSQ211836	21	18	36	99
MCSQ211842	21	18	42	111
MCSQ212430	21	24	30	105
MCSQ212434	21	24	34	114
MCSQ212436	21	24	36	118
MCSQ212442	21	24	42	131
MCSQ241830	24	18	30	97
MCSQ241834	24	18	34	106
MCSQ241836	24	18	36	110
MCSQ241842	24	18	42	122
MCSQ242430	24	24	30	115
MCSQ242434	24	24	34	125
MCSQ242436	24	24	36	130
MCSQ242442	24	24	42	144
MCSQ301830	30	18	30	117
MCSQ301834	30	18	34	126
MCSQ301836	30	18	36	131
MCSQ301842	30	18	42	146
MCSQ302430	30	24	30	137
MCSQ302434	30	24	34	148
MCSQ302436	30	24	36	153
MCSQ302442	30	24	42	170
MCSQ361830	36	18	30	136
MCSQ361834	36	18	34	147
MCSQ361836	36	18	36	153
MCSQ361842	36	18	42	169
MCSQ362430	36	24	30	159
MCSQ362434	36	24	34	171
MCSQ362436	36	24	36	177
MCSQ362442	36	24	42	195
MCSQ421830	42	18	30	156

Two Drawers with Top (cont.)

MODEL #	WIDTH	DEPTH	HEIGHT	WEIGHT
MCSQ421834	42	18	34	168
MCSQ421836	42	18	36	174
MCSQ421842	42	18	42	192
MCSQ422430	42	24	30	181
MCSQ422434	42	24	34	194
MCSQ422436	42	24	36	201
MCSQ422442	42	24	42	221

No upcharge to modify dimensions.

Drawers are evenly spaced and come with hanging file rails. Modified drawer height configurations are available. Tops available with curved fronts and other options.

Three Drawers with Top (cont.)

MODEL #	WIDTH	DEPTH	HEIGHT	WEIGHT
MCSM301830	30	18	30	117
MCSM301834	30	18	34	126
MCSM301836	30	18	36	131
MCSM301842	30	18	42	146
MCSM302430	30	24	30	137
MCSM302434	30	24	34	148
MCSM302436	30	24	36	153
MCSM302442	30	24	42	170
MCSM361830	36	18	30	136
MCSM361834	36	18	34	147
MCSM361836	36	18	36	153
MCSM361842	36	18	42	169
MCSM362430	36	24	30	159
MCSM362434	36	24	34	171
MCSM362436	36	24	36	177
MCSM362442	36	24	42	195
MCSM421830	42	18	30	156
MCSM421834	42	18	34	168
MCSM421836	42	18	36	174
MCSM421842	42	18	42	192
MCSM422430	42	24	30	181
MCSM422434	42	24	34	194
MCSM422436	42	24	36	201
MCSM422442	42	24	42	221

No upcharge to modify dimensions.

Drawers are evenly spaced. Modified drawer height configurations are available. Tops available with curved fronts and other options.

Three Drawers with Top

MCSM

MODEL #	WIDTH	DEPTH	HEIGHT	WEIGHT
MCSM151830	15	18	30	68
MCSM151834	15	18	34	75
MCSM151836	15	18	36	78
MCSM151842	15	18	42	88
MCSM152430	15	24	30	83
MCSM152434	15	24	34	91
MCSM152436	15	24	36	94
MCSM152442	15	24	42	106
MCSM181830	18	18	30	78
MCSM181834	18	18	34	85
MCSM181836	18	18	36	89
MCSM181842	18	18	42	96
MCSM182430	18	24	30	94
MCSM182434	18	24	34	102
MCSM182436	18	24	36	106
MCSM182442	18	24	42	119
MCSM211830	21	18	30	88
MCSM211834	21	18	34	95
MCSM211836	21	18	36	99
MCSM211842	21	18	42	111
MCSM212430	21	24	30	105
MCSM212434	21	24	34	114
MCSM212436	21	24	36	118
MCSM212442	21	24	42	131
MCSM241830	24	18	30	96
MCSM241834	24	18	34	105
MCSM241836	24	18	36	109
MCSM241842	24	18	42	121
MCSM242430	24	24	30	114
MCSM242434	24	24	34	125
MCSM242436	24	24	36	130
MCSM242442	24	24	42	144

Four Drawers with Top

MCSN

MODEL #	WIDTH	DEPTH	HEIGHT	WEIGHT
MCSN151830	15	18	30	73
MCSN151834	15	18	34	80
MCSN151836	15	18	36	83
MCSN151842	15	18	42	93
MCSN152430	15	24	30	88
MCSN152434	15	24	34	96
MCSN152436	15	24	36	99
MCSN152442	15	24	42	111
MCSN181830	18	18	30	83
MCSN181834	18	18	34	90
MCSN181836	18	18	36	94
MCSN181842	18	18	42	101
MCSN182430	18	24	30	99
MCSN182434	18	24	34	107
MCSN182436	18	24	36	111
MCSN182442	18	24	42	124

Four Drawers with Top (cont.)

MODEL #	WIDTH	DEPTH	HEIGHT	WEIGHT
MCSN211830	21	18	30	93
MCSN211834	21	18	34	100
MCSN211836	21	18	36	104
MCSN211842	21	18	42	116
MCSN212430	21	24	30	110
MCSN212434	21	24	34	119
MCSN212436	21	24	36	123
MCSN212442	21	24	42	136
MCSN241830	24	18	30	102
MCSN241834	24	18	34	111
MCSN241836	24	18	36	115
MCSN241842	24	18	42	127
MCSN242430	24	24	30	120
MCSN242434	24	24	34	130
MCSN242436	24	24	36	135
MCSN242442	24	24	42	149
MCSN301830	30	18	30	122
MCSN301834	30	18	34	131
MCSN301836	30	18	36	136
MCSN301842	30	18	42	151
MCSN302430	30	24	30	142
MCSN302434	30	24	34	153
MCSN302436	30	24	36	158
MCSN302442	30	24	42	175
MCSN361830	36	18	30	141
MCSN361834	36	18	34	152
MCSN361836	36	18	36	158
MCSN361842	36	18	42	174
MCSN362430	36	24	30	164
MCSN362434	36	24	34	176
MCSN362436	36	24	36	182
MCSN362442	36	24	42	200
MCSN421830	42	18	30	161
MCSN421834	42	18	34	173
MCSN421836	42	18	36	179
MCSN421842	42	18	42	197
MCSN422430	42	24	30	186
MCSN422434	42	24	34	199
MCSN422436	42	24	36	206
MCSN422442	42	24	42	226

No upcharge to modify dimensions.

Drawer heights may be modified and additional drawers added up to a 7 drawer maximum.

Tops available with curved fronts and other options.

Desktop Storage with Left Doors and 2 Adjustable Shelves



MCSO

MODEL #	WIDTH	DEPTH	HEIGHT	WEIGHT
MCSO121842	12	18	42	76
MCSO121854	12	18	54	91
MCSO122442	12	24	42	92
MCSO122454	12	24	54	110

No upcharge to modify dimensions.

Special configurations available. All units come with 1 adjustable coat rod.

Desktop Storage with Right Doors and 2 Adjustable Shelves



MCSP

MODEL #	WIDTH	DEPTH	HEIGHT	WEIGHT
MCSP121842	12	18	42	76
MCSP121854	12	18	54	91
MCSP122442	12	24	42	92
MCSP122454	12	24	54	110

No upcharge to modify dimensions.

Special configurations available. All units come with 1 adjustable coat rod.

Wall Cabinets

How to Specify Your Options

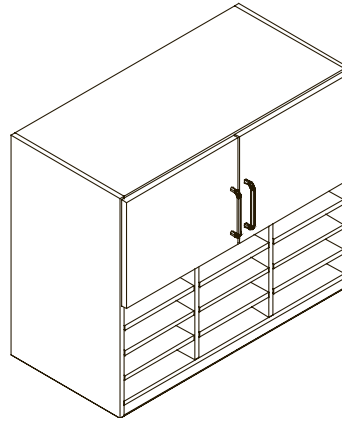

Door Front Options	
Model	Materials
LAM	Laminate
TFH	Thermofoil Harper
TFC	Thermofoil Celadon
TFP	Thermofoil Pavilion
FAC	Thermofoil/Acrylic-clear
FAF	Thermofoil/Acrylic-frosted
FGC	Thermofoil/Glass-clear
FGF	Thermofoil/Glass-frosted
AAC	Alum/Acrylic/clear
AAF	Alum/Acrylic-frosted
AGC	Alum/Glass-clear
AGF	Alum/Glass-frosted

Angled Top Option	
Model	Description
A	Sloped top
Change 2nd letter to A	
Example: MCSB becomes MASB	
Actual top purchased separately.	

Door Lock Options	
Model	Description
Y	Locking doors
N	No locks

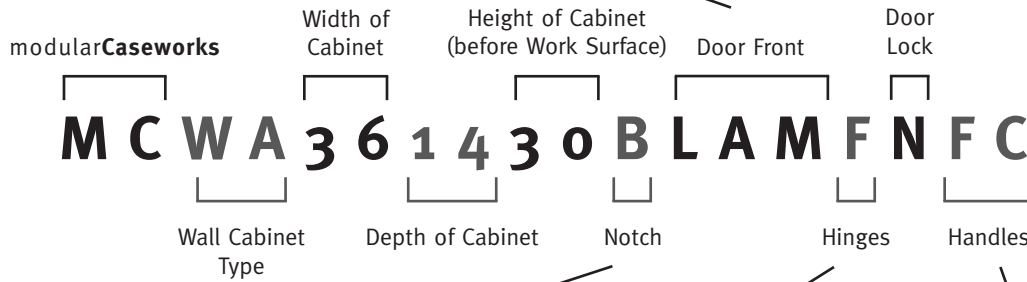

Notch	
Model	Description
N	None
L	Left Only
R	Right Only
B	Both

Hinge Options	
Model	Description
O	Overlay 110 degree
S	110 degree soft close
F	270 degree
K	5 knuckle

Handle Options		
Model	Description	
EL	Elliptical Black	007B
ES	Elliptical Silver	001A
CB	Crescent Black	007A
CS	Crescent Silver	117A
TC	Textured Crescent	100A
FC	Flared Crescent	101A
RS	Recessed Silver	999
WP	Wired Pull	102A
BS	6" Bar Handle	103A
BE	8" Bar Handle	104A
BT	10" Bar Handle	105A

Wall Cabinet Products

Doors and Adjustable Shelf

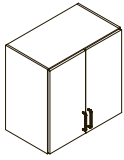

MCWA

MODEL #	WIDTH	DEPTH	HEIGHT	WEIGHT
MCWA241418	24	14	18	52
MCWA241424	24	14	24	61
MCWA241430	24	14	30	70
MCWA241436	24	14	36	78
MCWA241442	24	14	42	97
MCWA241818	24	18	18	61
MCWA241824	24	18	24	70
MCWA241830	24	18	30	80
MCWA241836	24	18	36	90
MCWA241842	24	18	42	112
MCWA301418	30	14	18	61
MCWA301424	30	14	24	71
MCWA301430	30	14	30	81
MCWA301436	30	14	36	92
MCWA301442	30	14	42	115
MCWA301818	30	18	18	72
MCWA301824	30	18	24	83
MCWA301830	30	18	30	93
MCWA301836	30	18	36	104
MCWA301842	30	18	42	130
MCWA361418	36	14	18	71
MCWA361424	36	14	24	82
MCWA361430	36	14	30	93
MCWA361436	36	14	36	105
MCWA361442	36	14	42	131
MCWA361818	36	18	18	82
MCWA361824	36	18	24	95
MCWA361830	36	18	30	107
MCWA361836	36	18	36	119
MCWA361842	36	18	42	148
MCWA421418	42	14	18	80
MCWA421424	42	14	24	92
MCWA421430	42	14	30	105
MCWA421436	42	14	36	118
MCWA421442	42	14	42	148
MCWA421818	42	18	18	93
MCWA421824	42	18	24	107
MCWA421830	42	18	30	120
MCWA421836	42	18	36	134
MCWA421842	42	18	42	167

No upcharge to modify dimensions.

Actual depth of wall cabinets are 13³/₄" wide or 17³/₄" wide.

Left Door and Adjustable Shelf

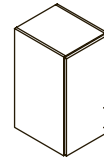

MCWB

MODEL #	WIDTH	DEPTH	HEIGHT	WEIGHT
MCWB121418	12	14	18	34
MCWB121424	12	14	24	40
MCWB121430	12	14	30	46
MCWB121436	12	14	36	52
MCWB121442	12	14	42	65
MCWB121818	12	18	18	40
MCWB121824	12	18	24	46
MCWB121830	12	18	30	53
MCWB121836	12	18	36	60
MCWB121842	12	18	42	75
MCWB151418	15	14	18	39
MCWB151424	15	14	24	45
MCWB151430	15	14	30	52
MCWB151436	15	14	36	58
MCWB151442	15	14	42	73
MCWB151818	15	18	18	45
MCWB151824	15	18	24	52
MCWB151830	15	18	30	60
MCWB151836	15	18	36	67
MCWB151842	15	18	42	84
MCWB181418	18	14	18	43
MCWB181424	18	14	24	50
MCWB181430	18	14	30	58
MCWB181436	18	14	36	65
MCWB181442	18	14	42	81
MCWB181818	18	18	18	50
MCWB181824	18	18	24	58
MCWB181830	18	18	30	67
MCWB181836	18	18	36	75
MCWB181842	18	18	42	94
MCWB231418	23	14	18	54
MCWB231424	23	14	24	63
MCWB231430	23	14	30	73
MCWB231436	23	14	36	81
MCWB231442	23	14	42	101
MCWB231818	23	18	18	63
MCWB231824	23	18	24	73
MCWB231830	23	18	30	85
MCWB231836	23	18	36	94
MCWB231842	23	18	42	118

No upcharge to modify dimensions.

Actual depth of wall cabinets are 13³/₄" wide or 17³/₄" wide.

Right Door and Adjustable Shelf



MODEL #	WIDTH	DEPTH	HEIGHT	WEIGHT
MCWC121418	12	14	18	34
MCWC121424	12	14	24	40
MCWC121430	12	14	30	46
MCWC121436	12	14	36	52
MCWC121442	12	14	42	65
MCWC121818	12	18	18	40
MCWC121824	12	18	24	46
MCWC121830	12	18	30	53
MCWC121836	12	18	36	60
MCWC121842	12	18	42	75
MCWC151418	15	14	18	39
MCWC151424	15	14	24	45
MCWC151430	15	14	30	52
MCWC151436	15	14	36	58
MCWC151442	15	14	42	73
MCWC151818	15	18	18	45
MCWC151824	15	18	24	52
MCWC151830	15	18	30	60
MCWC151836	15	18	36	67
MCWC151842	15	18	42	84
MCWC181418	18	14	18	43
MCWC181424	18	14	24	50
MCWC181430	18	14	30	58
MCWC181436	18	14	36	65
MCWC181442	18	14	42	81
MCWC181818	18	18	18	50
MCWC181824	18	18	24	58
MCWC181830	18	18	30	67
MCWC181836	18	18	36	75
MCWC181842	18	18	42	94
MCWC231418	23	14	18	54
MCWC231424	23	14	24	63
MCWC231430	23	14	30	73
MCWC231436	23	14	36	81
MCWC231442	23	14	42	101
MCWC231818	23	18	18	63
MCWC231824	23	18	24	73
MCWC231830	23	18	30	85
MCWC231836	23	18	36	94
MCWC231842	23	18	42	118

No upcharge to modify dimensions.

Actual depth of wall cabinets are 13^{3/4}" wide or 17^{3/4}" wide.

Open with Adjustable Shelf

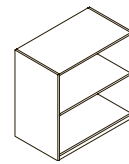

MODEL #	WIDTH	DEPTH	HEIGHT	WEIGHT
MCWD121418	12	14	18	30
MCWD121424	12	14	24	34
MCWD121430	12	14	30	39
MCWD121436	12	14	36	43
MCWD121442	12	14	42	51
MCWD121818	12	18	18	35
MCWD121824	12	18	24	41
MCWD121830	12	18	30	46
MCWD121836	12	18	36	51
MCWD121842	12	18	42	62
MCWD151418	15	14	18	33
MCWD151424	15	14	24	38
MCWD151430	15	14	30	43
MCWD151436	15	14	36	48
MCWD151442	15	14	42	57
MCWD151818	15	18	18	40
MCWD151824	15	18	24	45
MCWD151830	15	18	30	51
MCWD151836	15	18	36	57
MCWD151842	15	18	42	70
MCWD181418	18	14	18	37
MCWD181424	18	14	24	42
MCWD181430	18	14	30	47
MCWD181436	18	14	36	52
MCWD181442	18	14	42	63
MCWD181818	18	18	18	44
MCWD181824	18	18	24	50
MCWD181830	18	18	30	56
MCWD181836	18	18	36	62
MCWD181842	18	18	42	77
MCWD241418	24	14	18	44
MCWD241424	24	14	24	50
MCWD241430	24	14	30	56
MCWD241436	24	14	36	61
MCWD241442	24	14	42	75
MCWD241818	24	18	18	52
MCWD241824	24	18	24	59
MCWD241830	24	18	30	66
MCWD241836	24	18	36	73
MCWD241842	24	18	42	91
MCWD301418	30	14	18	51
MCWD301424	30	14	24	57
MCWD301430	30	14	30	64
MCWD301436	30	14	36	71
MCWD301442	30	14	42	88
MCWD301818	30	18	18	61
MCWD301824	30	18	24	69
MCWD301830	30	18	30	76
MCWD301836	30	18	36	83

Open with Adjustable Shelf (cont.)

MODEL #	WIDTH	DEPTH	HEIGHT	WEIGHT
MCWD301842	30	18	42	105
MCWD361418	36	14	18	58
MCWD361424	36	14	24	65
MCWD361430	36	14	30	72
MCWD361436	36	14	36	80
MCWD361442	36	14	42	100
MCWD361818	36	18	18	70
MCWD361824	36	18	24	78
MCWD361830	36	18	30	86
MCWD361836	36	18	36	94
MCWD361842	36	18	42	119
MCWD421418	42	14	18	65
MCWD421424	42	14	24	73
MCWD421430	42	14	30	81
MCWD421436	42	14	36	89
MCWD421442	42	14	42	112
MCWD421818	42	18	18	78
MCWD421824	42	18	24	87
MCWD421830	42	18	30	96
MCWD421836	42	18	36	105
MCWD421842	42	18	42	133

No upcharge to modify dimensions.
Actual depth of wall cabinets are 13³/₄" wide or 17³/₄" wide.

Sorter with Shelves*



MODEL #	WIDTH	DEPTH	HEIGHT	WEIGHT
Standard Shelves				
MCWE241430	24 ³ / ₄	14	30	60
MCWE241436	24 ³ / ₄	14	36	67
MCWE241442	24 ³ / ₄	14	42	84
MCWE361430	36	14	30	80
MCWE361436	36	14	36	90
MCWE361442	36	14	42	113

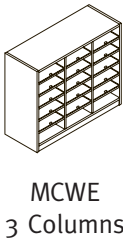

MODEL #	WIDTH	DEPTH	HEIGHT	WEIGHT
Legal Shelves				
MCWE241830	24 ³ / ₄	18	30	69
MCWE241836	24 ³ / ₄	18	36	78
MCWE241842	24 ³ / ₄	18	42	98
MCWE361830	36	18	30	93
MCWE361836	36	18	36	104
MCWE361842	36	18	42	130
Oversized Shelves				
MCWE281830	28 ³ / ₄	18	30	75
MCWE281836	28 ³ / ₄	18	36	83
MCWE281842	28 ³ / ₄	18	42	104
MCWE421830	42	18	30	101
MCWE421836	42	18	36	113
MCWE421842	42	18	36	141

Sorter with Shelves* (cont.)

No upcharge to modify height dimension.
*Shaded selections have 15 shelves; unshaded selections have 10.
Actual depth of wall cabinets are 13³/₄" wide or 17³/₄" wide.

Sorter with Doors and Shelves*



MODEL #	WIDTH	DEPTH	HEIGHT	WEIGHT
Standard Shelves				
MCWF241430	24 ³ / ₄	14	30	67
MCWF241436	24 ³ / ₄	14	36	75
MCWF241442	24 ³ / ₄	14	42	94
MCWF361430	36	14	30	90
MCWF361436	36	14	36	100
MCWF361442	36	14	42	125

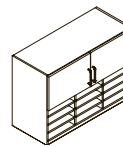

MODEL #	WIDTH	DEPTH	HEIGHT	WEIGHT
Legal Shelves				
MCWF241830	24 ³ / ₄	18	30	78
MCWF241836	24 ³ / ₄	18	36	87
MCWF241842	24 ³ / ₄	18	42	109
MCWF361830	36	18	30	104
MCWF361836	36	18	36	116
MCWF361842	36	18	42	145
Oversized Shelves				
MCWF281830	28 ³ / ₄	18	30	85
MCWF281836	28 ³ / ₄	18	36	95
MCWF281842	28 ³ / ₄	18	42	119
MCWF421830	42	18	30	115
MCWF421836	42	18	36	128
MCWF421842	42	18	42	160

No upcharge to modify height dimension.
*Shaded selections have 9 shelves; unshaded selections have 6.
Actual depth of wall cabinets are 13³/₄" wide or 17³/₄" wide.

Open with Doors

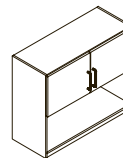

MODEL #	WIDTH	DEPTH	HEIGHT	WEIGHT
MCWG241430	24	14	30	63
MCWG241436	24	14	36	70
MCWG241442	24	14	42	88
MCWG241830	24	18	30	73
MCWG241836	24	18	36	81
MCWG241842	24	18	42	101
MCWG301430	30	14	30	73
MCWG301436	30	14	36	81
MCWG301442	30	14	42	101
MCWG301830	30	18	30	85
MCWG301836	30	18	36	94

Open with Doors (cont.)

MODEL #	WIDTH	DEPTH	HEIGHT	WEIGHT
MCWG301842	30	18	42	118
MCWG361430	36	14	30	83
MCWG361436	36	14	36	92
MCWG361442	36	14	42	115
MCWG361830	36	18	30	96
MCWG361836	36	18	36	107
MCWG361842	36	18	42	134
MCWG421830	42	18	30	108
MCWG421836	42	18	36	119
MCWG421842	42	18	42	149

No upcharge to modify dimensions.

Actual depth of wall cabinets are 13³/₄" wide or 17³/₄" wide.

Open with Right Door

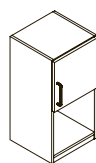

MCWI

MODEL #	WIDTH	DEPTH	HEIGHT	WEIGHT
MCWI121430	12	14	30	42
MCWI121436	12	14	36	47
MCWI121442	12	14	42	59
MCWI121830	12	18	30	50
MCWI121836	12	18	36	56
MCWI121842	12	18	42	70
MCWI151430	15	14	30	47
MCWI151436	15	14	36	53
MCWI151442	15	14	42	66
MCWI151830	15	18	30	55
MCWI151836	15	18	36	62
MCWI151842	15	18	42	78
MCWI181430	18	14	30	52
MCWI181436	18	14	36	59
MCWI181442	18	14	42	74
MCWI181830	18	18	30	61
MCWI181836	18	18	36	68
MCWI181842	18	18	42	85
MCWI231430	23	14	30	64
MCWI231436	23	14	36	74
MCWI231442	23	14	42	93
MCWI231830	23	18	30	74
MCWI231836	23	18	36	83
MCWI231842	23	18	42	104

No upcharge to modify dimensions.

Actual depth of wall cabinets are 13³/₄" wide or 17³/₄" wide.

Open with Left Door

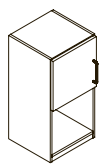

MCWH

MODEL #	WIDTH	DEPTH	HEIGHT	WEIGHT
MCWH121430	12	14	30	42
MCWH121436	12	14	36	47
MCWH121442	12	14	42	59
MCWH121830	12	18	30	50
MCWH121836	12	18	36	56
MCWH121842	12	18	42	70
MCWH151430	15	14	30	47
MCWH151436	15	14	36	53
MCWH151442	15	14	42	66
MCWH151830	15	18	30	55
MCWH151836	15	18	36	62
MCWH151842	15	18	42	78
MCWH181430	18	14	30	52
MCWH181436	18	14	36	59
MCWH181442	18	14	42	74
MCWH181830	18	18	30	61
MCWH181836	18	18	36	68
MCWH181842	18	18	42	85
MCWH231430	23	14	30	64
MCWH231436	23	14	36	74
MCWH231442	23	14	42	93
MCWH231830	23	18	30	74
MCWH231836	23	18	36	83
MCWH231842	23	18	42	104

No upcharge to modify dimensions.

Actual depth of wall cabinets are 13³/₄" wide or 17³/₄" wide.

Vertical Slots and Doors

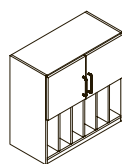

MCWJ

MODEL #	WIDTH	DEPTH	HEIGHT	WEIGHT
MCWJ241430	24	14	30	73
MCWJ241436	24	14	36	83
MCWJ241442	24	14	42	104
MCWJ241830	24	18	30	87
MCWJ241836	24	18	36	99
MCWJ241842	24	18	42	124
MCWJ301430	30	14	30	86
MCWJ301436	30	14	36	98
MCWJ301442	30	14	42	123
MCWJ301830	30	18	30	102
MCWJ301836	30	18	36	116
MCWJ301842	30	18	42	145
MCWJ361430	36	14	30	99
MCWJ361436	36	14	36	113
MCWJ361442	36	14	42	141
MCWJ361830	36	18	30	117
MCWJ361836	36	18	36	134
MCWJ361842	36	18	42	168

Vertical Slots and Doors (cont.)

MODEL #	WIDTH	DEPTH	HEIGHT	WEIGHT
MCWJ421430	42	14	30	111
MCWJ421436	42	14	36	127
MCWJ421442	42	14	42	159
MCWJ421830	42	18	30	132
MCWJ421836	42	18	36	151
MCWJ421842	42	18	42	189

No upcharge to modify dimensions.

Dividers are fixed with approximately 3" wide openings.

Actual depth of wall cabinets are 13³/₄" wide or 17³/₄" wide.

Upper Shelf



MODEL #	WIDTH	DEPTH	HEIGHT	WEIGHT
MCWO361209	36	12	9	40
MCWO421209	42	12	9	42
MCWO481209	48	12	9	45
MCWO601209	60	12	9	49

MCWO
No upcharge to modify dimensions.

Corner with Doors

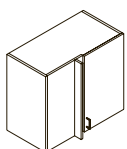

See page 37 for ordering instructions.

MODEL #	WIDTH	DEPTH	HEIGHT	WEIGHT
MCWM351418	35	14	18	54
MCWM351424	35	14	24	63
MCWM351430	35	14	30	73
MCWM351436	35	14	36	82
MCWM351442	35	14	42	103
MCWM391818	39	18	18	66
MCWM391824	39	18	24	77
MCWM391830	39	18	30	88
MCWM391836	39	18	36	99
MCWM391842	39	18	42	124

No upcharge to modify dimensions.

Actual depth of wall cabinets are 13³/₄" wide or 17³/₄" wide.

Open Corner

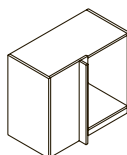

See page 37 for ordering instructions.

MODEL #	WIDTH	DEPTH	HEIGHT	WEIGHT
MCWN351418	35	14	18	48
MCWN351424	35	14	24	55
MCWN351430	35	14	30	62
MCWN351436	35	14	36	70
MCWN351442	35	14	42	88
MCWN391818	39	18	18	60
MCWN391824	39	18	24	69
MCWN391830	39	18	30	77
MCWN391836	39	18	36	86
MCWN391842	39	18	42	108

No upcharge to modify dimensions.

Actual depth of wall cabinets are 13³/₄" wide or 17³/₄" wide.

Corner Cabinets

How to Calculate Corners Using Base Cabinet Corner Fillers

MCPA24___
LEG PANELS

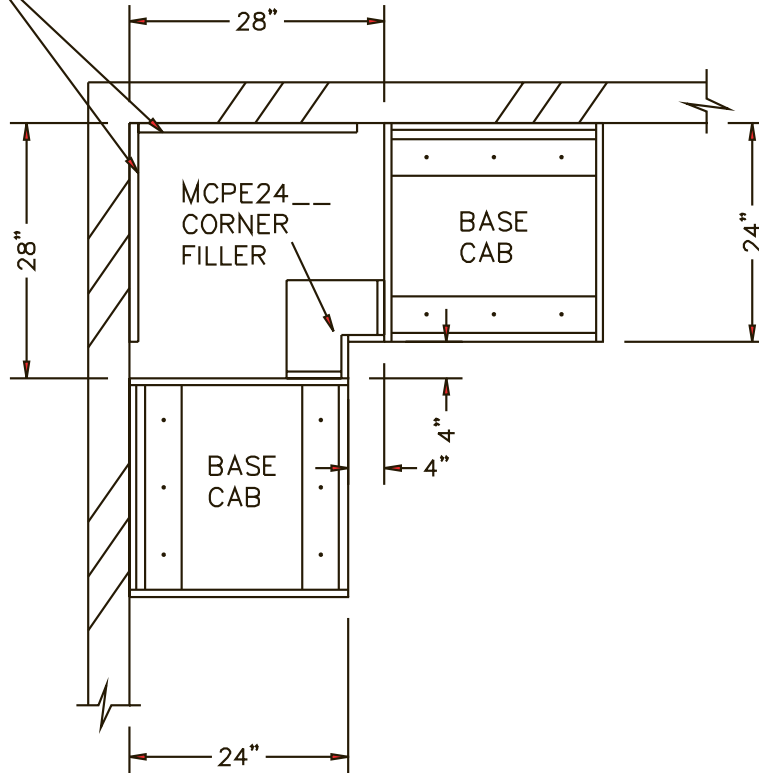

BASE CABINET CORNER FILLER
– 24" DEEP BASE CABINETS

To calculate the corner spacing for a 24" deep base cabinet subtract 28" from each corner wall. This allows you to use the base cabinet corner filler (MCPE24___). The counter top that extends into the dead corner space must be supported in the corners with (2) leg panels (MCPA24___). See page 49-50 to order.

BASE CABINET CORNER FILLER
– 30" DEEP BASE CABINETS

To calculate the corner spacing for a 30" deep base cabinet subtract 34" from each corner wall. This allows you to use the base cabinet corner filler (MCPE30___). The counter top that extends into the dead corner space must be supported in the corners with (2) leg panels (MCPA30___). See page 49-50 to order.

MCPA30___
LEG PANELS

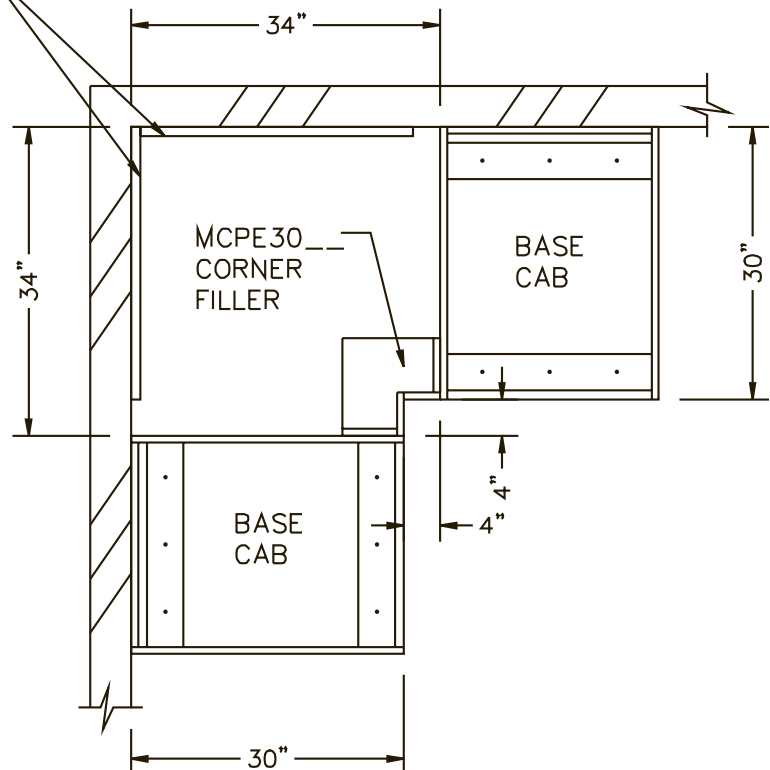

How to Calculate Corners Using Wall Cabinet Corner Fillers

WALL CABINET CORNER FILLER - 13³/₄" DEEP WALL CABINETS

To calculate the corner spacing for a 13³/₄" deep wall cabinet subtract 17" from each corner wall. This allows you to use the wall cabinet corner filler (MCPG14___). See page 50 to order.

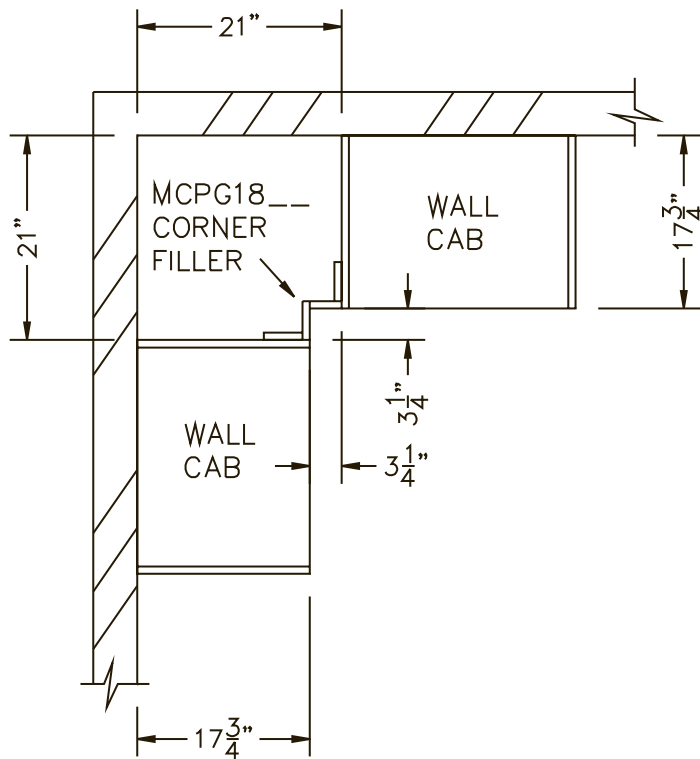
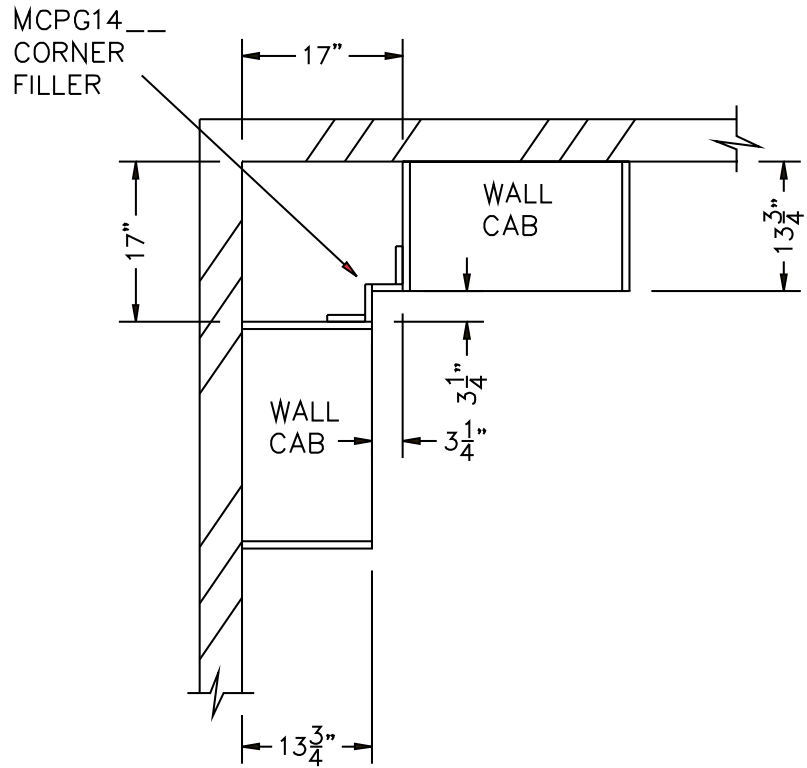

WALL CABINET CORNER FILLER - 17³/₄" DEEP WALL CABINETS

To calculate the corner spacing for a 17³/₄" deep wall cabinet subtract 21" from each corner wall. This allows you to use the wall cabinet corner filler (MCPG18___). See page 50 to order.

How to Calculate Corners Using Corner Base Cabinets

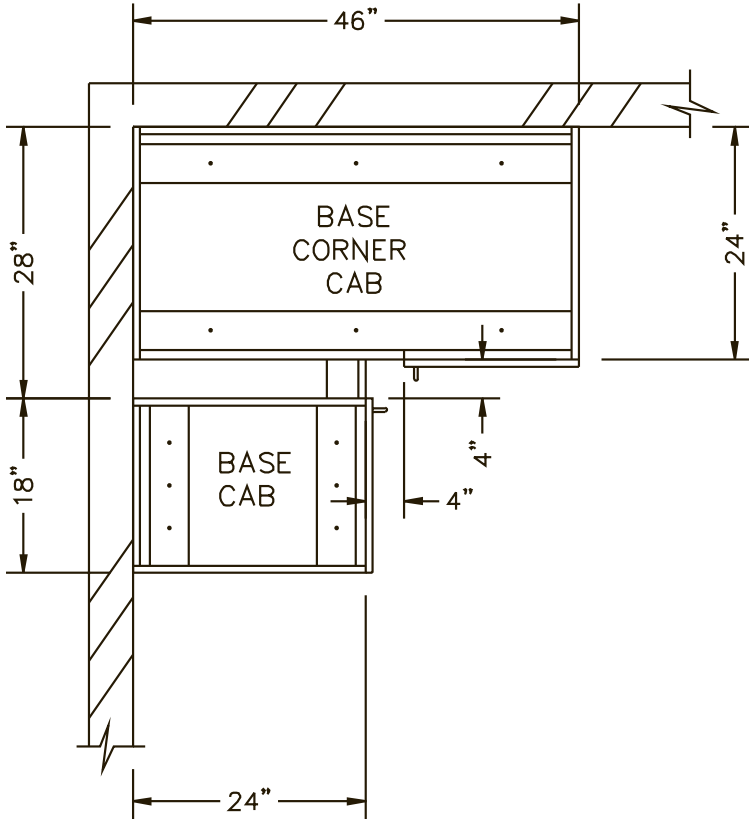

BASE CORNER CABINET – 24" DEEP BASE CABINETS

To calculate the corner spacing for a 24" deep base corner cabinet subtract 46" from each corner wall. This allows you to use the 46" wide base corner cabinet (MCBO4624__ or MCBP4624__) and an 18" wide base cabinet on the opposite wall (MCBB1824__ or MCBD1824__). See page 11 to order.

BASE CORNER CABINET – 30" DEEP BASE CABINETS

To calculate the corner spacing for a 30" deep base corner cabinet subtract 52" from each corner wall. This allows you to use the 52" wide base corner cabinet (MCBO5230__ or MCBP5230__) and an 18" wide base cabinet on the opposite wall (MCBB1830__ or MCBD1830__). See page 11 to order.

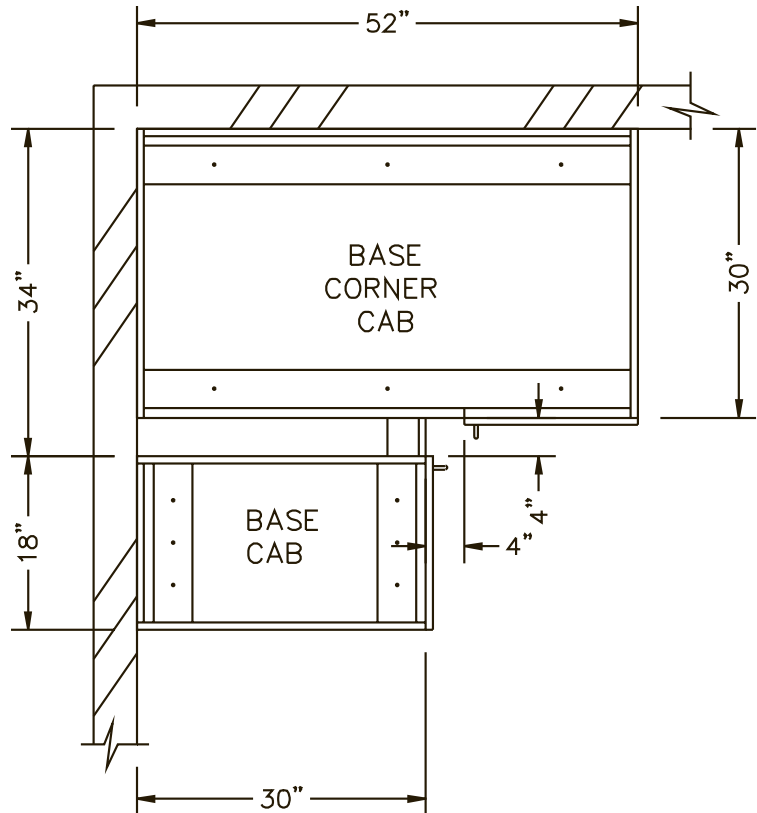

How to Calculate Corners Using Corner Wall Cabinets

WALL CORNER CABINET – 13³/₄" DEEP WALL CABINETS

To calculate the corner spacing for a 13³/₄" deep wall corner cabinet subtract 35" from each corner wall. This allows you to use the 35" wide base corner cabinet (MCWM3514__ or MCWN3514__) and an 18" wide wall cabinet on the opposite wall (MCWB1814__ or MCWD1814__). See page 33 to order.

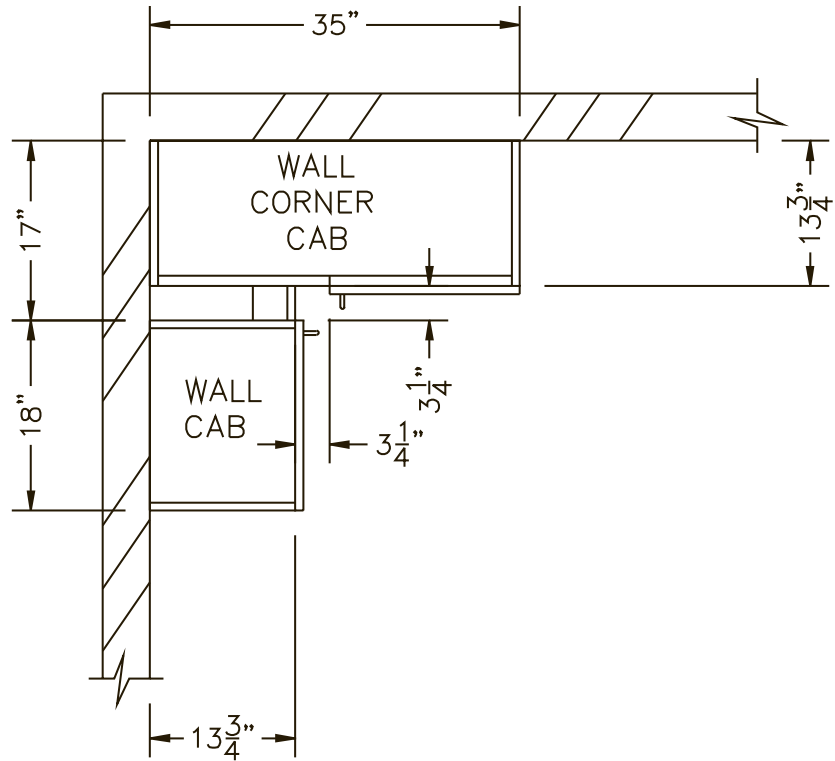

WALL CORNER CABINET – 17³/₄" DEEP WALL CABINETS

To calculate the corner spacing for a 17³/₄" deep wall corner cabinet subtract 39" from each corner wall. This allows you to use the 39" wide base corner cabinet (MCWM3918__ or MCWN3918__) and an 18" wide wall cabinet on the opposite wall (MCWB1818__ or MCWD1818__). See page 33 to order.

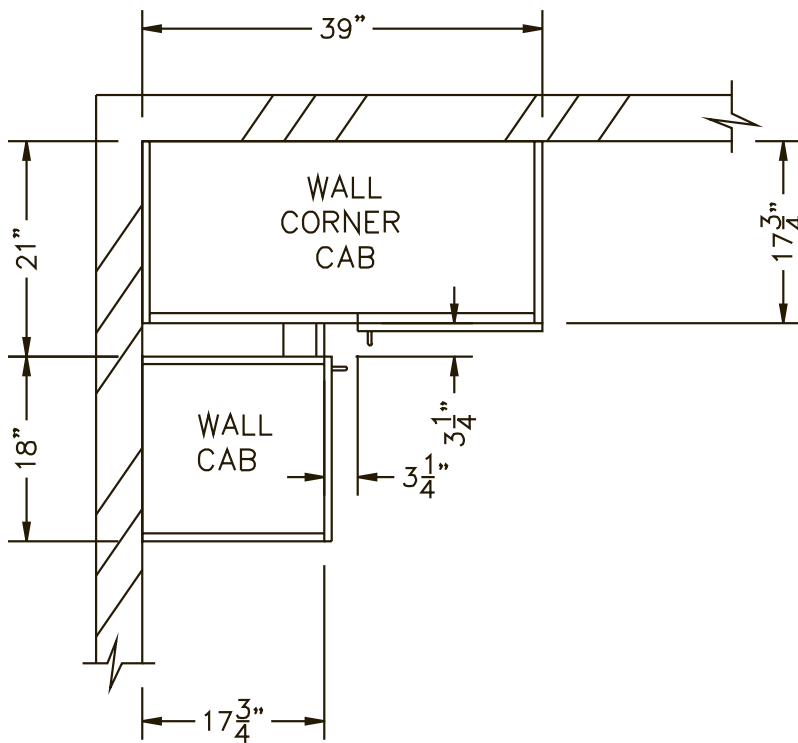

Specialty

How to Specify Your Options

HEADWALLS

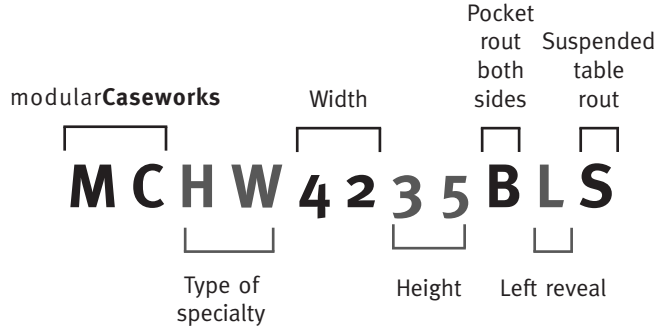

Headwalls laminate panels are designed to protect walls. They are hung on walls using a concealed bracket. Pocket routs and reveals may be added for ease of installation.

SUSPENDED TABLES

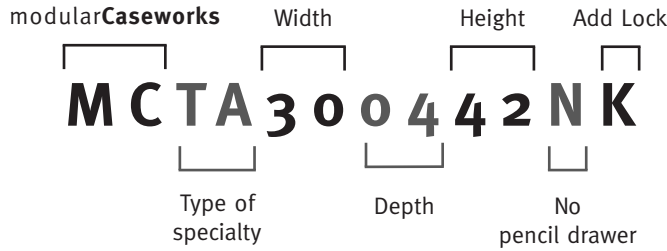

Suspended tables have a 4" face on 3 sides with pencil drawer on front. They are suspended by brackets (sold separately) and may be used in conjunction with Headwalls. When the "S" is added to the end of the Headwall model, special routs are put in to conceal the brackets which are attached to the actual wall.

TABLES WITH PEDESTAL

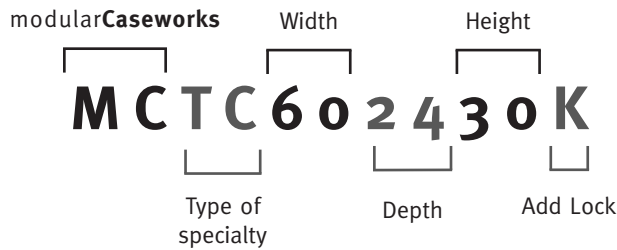

Tables with pedestals have full modesty's standard and 12" wide box/box/file drawers.

SQUARE PANEL

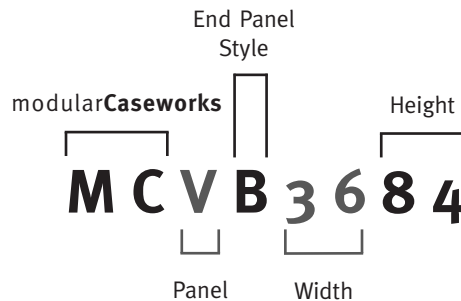

Specialty Products

Headwalls



MCHW

MODEL #	WIDTH	DEPTH	HEIGHT	WEIGHT
MCHW1268	12	3/4	68	19
MCHW1272	12	3/4	72	21
MCHW1280	12	3/4	80	23
MCHW1284	12	3/4	84	24
MCHW1868	18	3/4	68	29
MCHW1872	18	3/4	72	31
MCHW1880	18	3/4	80	35
MCHW1884	18	3/4	84	37
MCHW2468	24	3/4	68	39
MCHW2472	24	3/4	72	41
MCHW2480	24	3/4	80	46
MCHW2484	24	3/4	84	49
MCHW3068	30	3/4	68	49
MCHW3072	30	3/4	72	52
MCHW3080	30	3/4	80	58
MCHW3084	30	3/4	84	61
MCHW3668	36	3/4	68	58
MCHW3672	36	3/4	72	62
MCHW3680	36	3/4	80	69
MCHW3684	36	3/4	84	73
MCHW4268	42	3/4	68	68
MCHW4272	42	3/4	72	72
MCHW4280	42	3/4	80	81
MCHW4284	42	3/4	84	85
MCHW4868	48	3/4	68	78
MCHW4872	48	3/4	72	83
MCHW4880	48	3/4	80	93
MCHW4884	48	3/4	84	97
MCHW5468	54	3/4	68	88
MCHW5472	54	3/4	72	93
MCHW5480	54	3/4	80	104
MCHW5484	54	3/4	84	110
MCHW6068	60	3/4	68	97
MCHW6072	60	3/4	72	104
MCHW6080	60	3/4	80	116
MCHW6084	60	3/4	84	122

No upcharge to modify dimensions.
 Add B-for both, R-for right, L-for left or N-for none to end of model for pocket routs.
 Add B-for both, R-for right, L-for left or N-for none to end of model.
 Routings to accommodate suspended table brackets are available.

Mobile Island



MCMA

MODEL #	WIDTH	DEPTH	HEIGHT	WEIGHT
MCMA482438	48	24	38	225
MCMA602438	60	24	38	250

Mobile Island includes powder coated steel kickplate to conceal the wheels.

Double Sided Bookcase

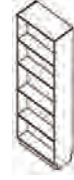

MCSR

MODEL #	WIDTH	DEPTH	HEIGHT	WEIGHT
MCSR181860	18	18	60	176
MCSR181866	18	18	66	185
MCSR181872	18	18	72	194
MCSR181878	18	18	78	202
MCSR181884	18	18	84	211
MCSR182460	18	24	60	231
MCSR182466	18	24	66	242
MCSR182472	18	24	72	253
MCSR182478	18	24	78	265
MCSR182484	18	24	84	276
MCSR241860	24	18	60	215
MCSR241866	24	18	66	225
MCSR241872	24	18	72	235
MCSR241878	24	18	78	244
MCSR241884	24	18	84	254
MCSR242460	24	24	60	283
MCSR242466	24	24	66	294
MCSR242472	24	24	72	306
MCSR242478	24	24	78	318
MCSR242484	24	24	84	330
MCSR301860	30	18	60	255
MCSR301866	30	18	66	265
MCSR301872	30	18	72	276
MCSR301878	30	18	78	286
MCSR301884	30	18	84	296
MCSR302460	30	24	60	334
MCSR302466	30	24	66	346
MCSR302472	30	24	72	359
MCSR302478	30	24	78	372
MCSR302484	30	24	84	384
MCSR361860	36	18	60	295
MCSR361866	36	18	66	306
MCSR361872	36	18	72	317
MCSR361878	36	18	78	327
MCSR361884	36	18	84	338
MCSR362460	36	24	60	385
MCSR362466	36	24	66	399
MCSR362472	36	24	72	412
MCSR362478	36	24	78	425
MCSR362484	36	24	84	438

Must be framed into a wall.

Pass Thru Cabinet



MCSV

MODEL #	WIDTH	DEPTH	HEIGHT	WEIGHT
MCSV182460	18	24	60	213
MCSV182466	18	24	66	228
MCSV182472	18	24	72	243
MCSV182478	18	24	78	258
MCSV182484	18	24	84	274
MCSV242460	24	24	60	262
MCSV242466	24	24	66	280
MCSV242472	24	24	72	298
MCSV242478	24	24	78	316
MCSV242484	24	24	84	334
MCSV302460	30	24	60	311
MCSV302466	30	24	66	332
MCSV302472	30	24	72	352
MCSV302478	30	24	78	373
MCSV302484	30	24	84	394
MCSV362460	36	24	60	360
MCSV362466	36	24	66	383
MCSV362472	36	24	72	407
MCSV362478	36	24	78	430
MCSV362484	36	24	84	454

Must be framed into a wall.

Suspended Table with Pencil Drawer



MCTA

MODEL #	WIDTH	DEPTH	HEIGHT	WEIGHT
MCTA300418	30	4	18	29
MCTA360418	36	4	18	33
MCTA420418	42	4	18	37

No upcharge to modify dimensions.
Brackets sold separately.

Suspended Table Brackets



MCTA1609

MODEL #	WIDTH	DEPTH	HEIGHT	WEIGHT
MCTA1609	4	16	9	15

Sold in pairs

Tables with Pedestal on Right

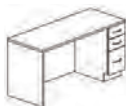

MCTD

MODEL #	WIDTH	DEPTH	HEIGHT	WEIGHT
MCTD362430	36	24	30	115
MCTD482430	48	24	30	135
MCTD602430	60	24	30	155
MCTD722430	72	24	30	175

No upcharge to modify dimensions.
Pedestal is a 3 drawer 12" wide box/box/file.
Special width pedestal available upon request.

Tables with Pedestal on Left

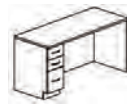

MCTC

MODEL #	WIDTH	DEPTH	HEIGHT	WEIGHT
MCTC362430	36	24	30	115
MCTC482430	48	24	30	135
MCCT602430	60	24	30	155
MCCT722430	72	24	30	175

No upcharge to modify dimensions.
Pedestal is a 3 drawer 12" wide box/box/file.
Special width pedestal available upon request.

Peninsula Tables with Pedestal on Right

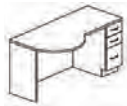

MCTE

MODEL #	WIDTH	DEPTH	HEIGHT	WEIGHT
MCTE483030	48	30	30	146
MCTE603030	60	30	30	170
MCTE723030	72	30	30	192

No upcharge to modify dimensions.
Pedestal is a 3 drawer 12" wide box/box/file.
Special width pedestal available upon request.

Peninsula Tables with Pedestal on Left

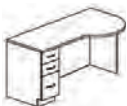

MCTF

MODEL #	WIDTH	DEPTH	HEIGHT	WEIGHT
MCTF483030	48	30	30	146
MCTF603030	60	30	30	170
MCTF723030	72	30	30	192

No upcharge to modify dimensions.
Pedestal is a 3 drawer 12" wide box/box/file.
Special width pedestal available upon request.

Pharmacy Panel



MCVA

MODEL #	WIDTH	DEPTH	HEIGHT	WEIGHT
MCVA1284	12	1	84	33
MCVA1884	18	1	84	50
MCVA2484	24	1	84	66
MCVA3084	30	1	84	83
MCVA3684	36	1	84	100
MCVA4284	42	1	84	116
MCVA4884	48	1	84	133

To order a pass thru/window, must specify dimension from floor and dimension of the opening. Wall cabinet able to be attached only with base attachment.

Pharmacy Straight End Panel



MCVB

MODEL #	WIDTH	DEPTH	HEIGHT	WEIGHT
MCVB1284	12	1	84	33
MCVB1884	18	1	84	50
MCVB2484	24	1	84	66
MCVB3084	30	1	84	83
MCVB3684	36	1	84	100
MCVB4284	42	1	84	116
MCVB4884	48	1	84	133
MCVB5484	54	1	84	149
MCVB6084	60	1	84	166

Straight end panels are placed at the end of a run of Pharmacy panels and covers base cabinet on one or both ends.

Pharmacy Contour Single End Panel



MCVC

MODEL #	WIDTH	DEPTH	HEIGHT	WEIGHT
MCVC2484	26 ^{1/2}	1	84	73
MCVC3084	30 ^{1/2}	1	84	84
MCVC3484	34 ^{1/2}	1	84	95

Contour end panels are placed at the end of a run of Pharmacy panels and covers base cabinet on one or both ends.

Pharmacy Contour Double End Panel



MCVD

MODEL #	WIDTH	DEPTH	HEIGHT	WEIGHT
MCVD5284	52	1	84	144
MCVD5484	54	1	84	149
MCVD5684	56	1	84	155
MCVD5884	58	1	84	161
MCVD6084	60	1	84	166

Contour end panels are placed at the end of a run of Pharmacy panels and covers base cabinet on one or both ends.

Pharmacy Above Worksurface End Panel



MCVE

MODEL #	WIDTH	DEPTH	HEIGHT	WEIGHT
MCVE1342	13	1	42	18
MCVE1348	13	1	48	21
MCVE1354	13	1	54	23

Above Worksurface end panels are placed at the end of a run of Pharmacy panels and covers base cabinet on one or both ends

Pharmacy Straight Shelf for Panel



MCVF

MODEL #	WIDTH	DEPTH	HEIGHT	WEIGHT
MCVF1212	12	12	1	4
MCVF1812	18	12	1	5
MCVF2412	24	12	1	7
MCVF3012	30	12	1	9
MCVF3612	36	12	1	11

Pharmacy Straight Shelf for Panel (cont.)

MODEL #	WIDTH	DEPTH	HEIGHT	WEIGHT
MCVF4212	42	12	1	13
MCVF4812	48	12	1	15

Designed to attach to Pharmacy panels. Straight Shelf easily adjusts by ratcheting to 5 different positions.

Pharmacy Corner Shelf for Panel



MCVG

MODEL #	WIDTH	DEPTH	HEIGHT	WEIGHT
MCVG2828	28	28	1	20
MCVG3434	34	34	1	34

Designed to attach to Pharmacy panels. Corner Shelf easily adjusts by ratcheting to 5 different positions.

Pharmacy Corner Stanchion



MCVI

MODEL #	HEIGHT	WEIGHT
MCVI	84	3

Pharmacy Panel Foot Single

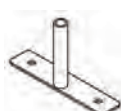

MCVHS

MODEL #	HEIGHT	WEIGHT
MCVHS	1	1

Pharmacy Panel Foot Double

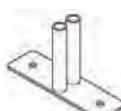

MCVHD

MODEL #	HEIGHT	WEIGHT
MCVHD	1	1

Pharmacy Wall Mounted Stanchion



MCVJ

MODEL #	HEIGHT	WEIGHT
MCVJ	84	3

Work Surfaces

How to Specify Your Options

Specify length.
Add all width
dimensions of base
cabinets to get work
surface length. Call if
work surfaces exceed
9 feet in length.

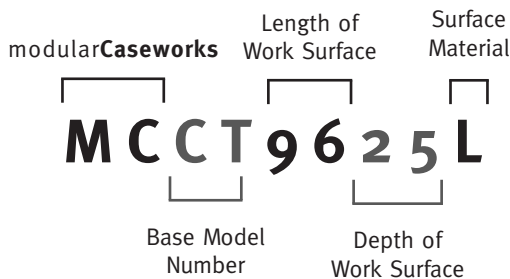

All work surfaces orders must be accompanied by a floor plan to ensure proper lengths and overhangs.

Construction

Work surfaces are constructed of 1¹/₁₆" thick high-pressure laminate (HPL) with industrial grade 40-50 lb. sub-strate backed with a .027 phenolic backer. When available, work surfaces are edged with 2mm impact resistant PVC edgebanding. Work surfaces are attached by wood screws (supplied) through the nailer strips on the top of the base cabinets.

The model numbers on page 36 and 37 represent the standard High Pressure Laminate surface. For special surfaces, add the corresponding letter to the end of the model number and calculate the appropriate cost (square foot of surface x cost per square foot.)

Add to Model #	Surface
C	Chemical Resistant
M	Marmoleum (bacterial resistant laminate)
H	High Ware (5 x the abrasion/scuff resistant laminate)
P	Phenolic Resin
E	Epoxy
S	Solid Surfacing (integrated sinks available)
T	Stainless Steel

*Call for availability of other work surfaces.

Call HAMILTON for pricing.

Work Surface Products

Laminate Work Surfaces

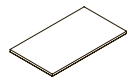

MCCT

MODEL #	WIDTH	DEPTH	WEIGHT
MCCT1225	12	25	13
MCCT1525	15	25	15
MCCT1825	18	25	17
MCCT2125	21	25	19
MCCT2425	24	25	22
MCCT3025	30	25	26
MCCT3325	33	25	28
MCCT3625	36	25	31
MCCT3925	39	25	33
MCCT4225	42	25	35
MCCT4525	45	25	37
MCCT4825	48	25	39
MCCT5125	51	25	42
MCCT5425	54	25	44
MCCT5725	57	25	46
MCCT6025	60	25	48
MCCT6325	63	25	50
MCCT6625	66	25	53
MCCT6925	69	25	55
MCCT7225	72	25	57
MCCT7525	75	25	59
MCCT7825	78	25	62
MCCT8125	81	25	64
MCCT8425	84	25	66
MCCT8725	87	25	68
MCCT9025	90	25	70
MCCT9325	93	25	72
MCCT9625	96	25	75
MCCT9925	99	25	78
MCCT10225	102	25	81
MCCT10525	105	25	84
MCCT10825	108	25	87
MCCT1231	12	31	15
MCCT1531	15	31	18
MCCT1831	18	31	20
MCCT2131	21	31	23
MCCT2431	24	31	26
MCCT3031	30	31	31
MCCT3331	33	31	34
MCCT3631	36	31	37
MCCT3931	39	31	40
MCCT4231	42	31	42
MCCT4531	45	31	45
MCCT4831	48	31	48
MCCT5131	51	31	51
MCCT5431	54	31	53
MCCT5731	57	31	56

Laminate Work Surfaces (cont.)

MODEL #	WIDTH	DEPTH	WEIGHT
MCCT6031	60	31	59
MCCT6331	63	31	62
MCCT6631	66	31	64
MCCT6931	69	31	67
MCCT7231	72	31	70
MCCT7531	75	31	73
MCCT7831	78	31	75
MCCT8131	81	31	78
MCCT8431	84	31	81
MCCT8731	87	31	84
MCCT9031	90	31	86
MCCT9331	93	31	88
MCCT9631	96	31	92
MCCT9631	96	31	92
MCCT10231	102	31	95
MCCT10531	105	31	105
MCCT10831	108	31	110
MCCT1237	12	37	15
MCCT1537	15	37	19
MCCT1837	18	37	23
MCCT2137	21	37	27
MCCT2437	24	37	31
MCCT3037	30	37	39
MCCT3337	33	37	42
MCCT3637	36	37	46
MCCT3937	39	37	50
MCCT4237	42	37	54
MCCT4537	45	37	58
MCCT4837	48	37	62
MCCT5137	51	37	66
MCCT5437	54	37	69
MCCT5737	57	37	73
MCCT6037	60	37	77
MCCT6337	63	37	81
MCCT6637	66	37	85
MCCT6937	69	37	89
MCCT7237	72	37	93
MCCT7537	75	37	96
MCCT7837	78	37	100
MCCT8137	81	37	104
MCCT8437	84	37	108
MCCT8737	87	37	112
MCCT9037	90	37	116
MCCT9337	93	37	119
MCCT9637	96	37	123
MCCT9937	99	37	127
MCCT10237	102	37	131
MCCT10537	105	37	135
MCCT10837	108	37	139

Laminate Work Surfaces (cont.)

MODEL #	WIDTH	DEPTH	WEIGHT
MCCT1248	12	48	18
MCCT1548	15	48	22
MCCT1848	18	48	27
MCCT2148	21	48	31
MCCT2448	24	48	35
MCCT3048	30	48	44
MCCT3348	33	48	49
MCCT3648	36	48	53
MCCT3948	39	48	58
MCCT4248	42	48	62
MCCT4548	45	48	66
MCCT4848	48	48	71
MCCT5148	51	48	75
MCCT5448	54	48	80
MCCT5748	57	48	84
MCCT6048	60	48	89
MCCT6348	63	48	93
MCCT6648	66	48	97
MCCT6948	69	48	102
MCCT7248	72	48	106
MCCT7548	75	48	111
MCCT7848	78	48	115
MCCT8148	81	48	119
MCCT8448	84	48	124
MCCT8748	87	48	128
MCCT9048	90	48	133
MCCT9348	93	48	137
MCCT9648	96	48	142
MCCT9948	99	48	146
MCCT10248	102	48	150
MCCT10548	105	48	155
MCCT10848	108	48	159
MCCT1260	12	60	22
MCCT1560	15	60	28
MCCT1860	18	60	33
MCCT2160	21	60	39
MCCT2460	24	60	44
MCCT3060	30	60	55
MCCT3360	33	60	61
MCCT3660	36	60	66
MCCT3960	39	60	72
MCCT4260	42	60	77
MCCT4560	45	60	83
MCCT4860	48	60	89
MCCT5160	51	60	94
MCCT5460	54	60	100
MCCT5760	57	60	105
MCCT6060	60	60	111
MCCT6360	63	60	116

Laminate Work Surfaces (cont.)

MODEL #	WIDTH	DEPTH	WEIGHT
MCCT6660	66	60	122
MCCT6960	69	60	127
MCCT7260	72	60	133
MCCT7560	75	60	138
MCCT7860	78	60	144
MCCT8160	81	60	149
MCCT8460	84	60	155
MCCT8760	87	60	160
MCCT9060	90	60	166
MCCT9360	93	60	171
MCCT9660	96	60	177
MCCT9960	99	60	183
MCCT10260	102	60	188
MCCT10560	105	60	194
MCCT10860	108	60	199

No upcharge to modify dimensions.

Back Splash

How to Specify Your Options

Specify length.
Add all width
dimensions of base
cabinets to get back
splash length. Call if
back splashes exceed
9 feet in length.

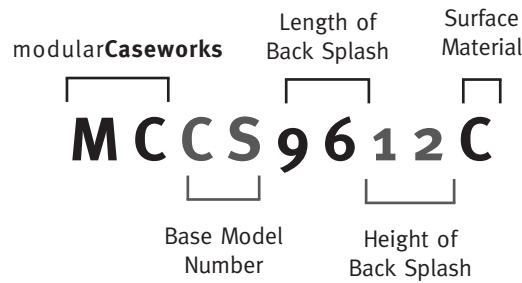

All back splash orders must be accompanied by a floor plan to ensure proper lengths and overhangs.

Construction

Back splashes are used to protect walls and to hide gaps caused by bowed or unsquare walls. They are constructed of 1¹/₁₆" thick high-pressure laminate (HPL) with industrial grade 40-50 lb. sub-strate backed with a .027 phenolic backer. When available, back splashes are edged with 1.5mm impact resistant PVC edgebanding. Back splashes are attached by installation crew. Suggested means of attaching are contractor grade adhesive like liquid nail (supplied by installer.)

The model numbers on pages 39 and 40 represent the standard High Pressure Laminate surface. For special surfaces, add the corresponding letter to the end of the model number and calculate the appropriate cost (square foot of surface x cost per square foot.)

Add to Model #	Surface
C	Chemical Resistant
M	Marmoleum (bacterial resistant laminate)
H	High Ware (5 x the abrasion/scuff resistant laminate)
P	Phenolic Resin
E	Epoxy
S	Solid Surfacing
T	Stainless Steel

*Call for availability of other work surfaces.

Call HAMILTON for pricing.

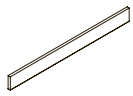
*Back Splash Products***Laminate Back Splashes (cont.)****Laminate Back Splashes**

MCCS

MODEL #	WIDTH	DEPTH	WEIGHT	MODEL #	WIDTH	DEPTH	WEIGHT
MCCS1204	12	4	5	MCCS6006	60	6	13
MCCS1504	15	4	6	MCCS6306	63	6	13
MCCS1804	18	4	6	MCCS6606	66	6	14
MCCS2104	21	4	6	MCCS6906	69	6	14
MCCS2404	24	4	7	MCCS7206	72	6	15
MCCS3004	30	4	8	MCCS7506	75	6	15
MCCS3304	33	4	8	MCCS7806	78	6	15
MCCS3604	36	4	8	MCCS8106	81	6	16
MCCS3904	39	4	9	MCCS8406	84	6	16
MCCS4204	42	4	9	MCCS8706	87	6	16
MCCS4504	45	4	9	MCCS9006	90	6	17
MCCS4804	48	4	10	MCCS9306	93	6	17
MCCS5104	51	4	10	MCCS9606	96	6	17
MCCS5404	54	4	10	MCCS9906	99	6	17
MCCS5704	57	4	11	MCCS10206	102	6	17
MCCS6004	60	4	11	MCCS10506	105	6	17
MCCS6304	63	4	11	MCCS10806	108	6	17
MCCS6604	66	4	12	MCCS1212	12	12	7
MCCS6904	69	4	12	MCCS1512	15	12	8
MCCS7204	72	4	13	MCCS1812	18	12	9
MCCS7504	75	4	13	MCCS2112	21	12	10
MCCS7804	78	4	13	MCCS2412	24	12	11
MCCS8104	81	4	14	MCCS3012	30	12	12
MCCS8404	84	4	14	MCCS3312	33	12	13
MCCS8704	87	4	14	MCCS3612	36	12	14
MCCS9004	90	4	15	MCCS3912	39	12	14
MCCS9304	93	4	15	MCCS4212	42	12	15
MCCS9604	96	4	15	MCCS4512	45	12	15
MCCS9904	99	4	15	MCCS4812	48	12	15
MCCS10204	102	4	15	MCCS5112	51	12	16
MCCS10504	105	4	15	MCCS5412	54	12	17
MCCS10804	108	4	15	MCCS5712	57	12	18
MCCS1206	12	6	7	MCCS6012	60	12	19
MCCS1506	15	6	8	MCCS6312	63	12	20
MCCS1806	18	6	8	MCCS6612	66	12	21
MCCS2106	21	6	8	MCCS6912	69	12	22
MCCS2406	24	6	9	MCCS7212	72	12	23
MCCS3006	30	6	10	MCCS7512	75	12	24
MCCS3306	33	6	10	MCCS7812	78	12	25
MCCS3606	36	6	10	MCCS8112	81	12	26
MCCS3906	39	6	11	MCCS8412	84	12	27
MCCS4206	42	6	11	MCCS8712	87	12	28
MCCS4506	45	6	11	MCCS9012	90	12	29
MCCS4806	48	6	12	MCCS9312	93	12	30
MCCS5106	51	6	12	MCCS9612	96	12	31
MCCS5406	54	6	12	MCCS9912	99	12	32
MCCS5706	57	6	13	MCCS10212	102	12	33
				MCCS10512	105	12	34
				MCCS10812	108	12	35

Laminate Back Splashes (con't.)

MODEL #	WIDTH	DEPTH	WEIGHT
MCCS1224	12	24	8
MCCS1524	15	24	10
MCCS1824	18	24	12
MCCS2124	21	24	13
MCCS2424	24	24	15
MCCS3024	30	24	19
MCCS3324	33	24	21
MCCS3624	36	24	23
MCCS3924	39	24	25
MCCS4224	42	24	27
MCCS4524	45	24	29
MCCS4824	48	24	31
MCCS5124	51	24	33
MCCS5424	54	24	35
MCCS5724	57	24	36
MCCS6024	60	24	38
MCCS6324	63	24	40
MCCS6624	66	24	42
MCCS6924	69	24	44
MCCS7224	72	24	46
MCCS7524	75	24	48
MCCS7824	78	24	50
MCCS8124	81	24	52
MCCS8424	84	24	54
MCCS8724	87	24	56
MCCS9024	90	24	58
MCCS9324	93	24	59
MCCS9624	96	24	61
MCCS9924	99	24	63
MCCS10224	102	24	65
MCCS10524	105	24	67
MCCS10824	108	24	69

No upcharge to modify dimensions.

Accessories

How to Specify Your Options

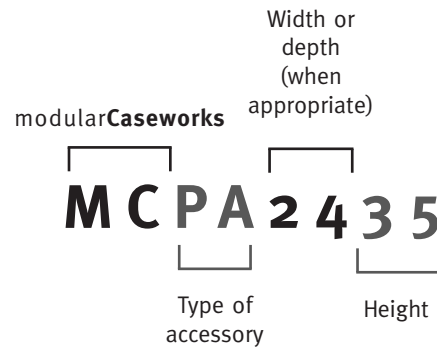

Selecting the Base Cabinet & Work Surface Accessories

Leg Panels & Radius Leg Panels Used to support work surfaces where no cabinet is desired. Pick the appropriate height and depth to match you work surface. Floor plan layouts must be submitted.

15" & Full Back Panels Used to support work surfaces where no cabinet is desired. Can be mounted to leg panels as well. Floor plan layouts must be submitted.

Base Cabinet Corner Filler Package Used to support work surfaces and to fill gaps created in L and U-shaped installations. See how to calculate corners on page 20. Floor plan layouts must be submitted.

Base and Storage Cabinet End Filler Used to support work surfaces and to fill gaps between the edge of base cabinets and walls where desired. Floor plan layouts must be submitted.

Adjustable Keyboard Tray and Tray with Mouse Made to mount under a work surface. Mark floor plan with locations.

Extended Kickplate used to fill gap in kickplates between end of cabinets and walls.

Selecting the Wall Cabinet Accessories

Wall Cabinet Corner Filler Used to fill gaps created in L and U-shaped installations between adjacent wall cabinets. See how to calculate corners on page 21. Floor plan layouts must be submitted.

Wall Cabinet Filler Used to fill gaps between the edge of wall cabinets and walls where desired. Floor plan layouts must be submitted.

Shelves Used to add additional adjustable shelves to units

- ◆ MCPS – Adjustable shelf for base cabinets
- ◆ MCPS – Adjustable shelf for wall cabinets
- ◆ RMS – Adjustable polyethylene module shelves
- ◆ WRMS – Adjustable wood modules shelves

Selecting Electrical, Grommet & Lighting Accessories

Task Lights All wall cabinets have 2” fascias that conceal task lights. Color: Black. Daisy chain task light available for a cost between \$122 and \$230.

Retractable Power Center Are pop up convenience outlet with 3 receptacles. Specify location on work surface. Don't forget to add a grommet (MCCBLO-3) in the back panel or bottom shelf to allow cord to plug in.

Grommet 2³/₈” round grommet made for cable management. Specify location in work surface, side, shelves or back.

Paper Slot 10” and 13” slot with grommet made for paper and cables. Specify location in work surface, side, back or door panel

Leg Panels

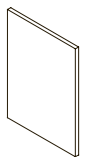

MCPA

MODEL #	WIDTH	HEIGHT	WEIGHT
MCPA2429	24	29	15
MCPA2433	24	33	16
MCPA2435	24	35	17
MCPA2441	24	41	20
MCPA3029	30	29	18
MCPA3033	30	33	20
MCPA3035	30	35	21
MCPA3041	30	41	25

No upcharge to modify dimensions.

Full Height Back Panels

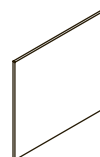

MCPD

MODEL #	WIDTH	HEIGHT	WEIGHT
MCPD3029	30	29	18
MCPD3033	30	33	20
MCPD3035	30	35	21
MCPD3041	30	41	25
MCPD3629	36	29	21
MCPD3633	36	33	24
MCPD3635	36	35	26
MCPD3641	36	41	30
MCPD4229	42	29	25
MCPD4233	42	33	28
MCPD4235	42	35	30
MCPD4241	42	41	32
MCPD4829	48	29	28
MCPD4833	48	33	31
MCPD4835	48	35	33
MCPD4841	48	41	35
MCPD6029	60	29	31
MCPD6033	60	33	34
MCPD6035	60	35	36
MCPD6041	60	41	38
MCPD7229	72	29	34
MCPD7233	72	33	37
MCPD7235	72	35	39
MCPD7241	72	41	41

No upcharge to modify dimensions.

Angled Leg Panels

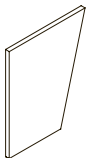

MCPB

MODEL #	WIDTH	HEIGHT	WEIGHT
MCPB2429	24	29	14
MCPB2433	24	33	15
MCPB2435	24	35	16
MCPB2441	24	41	20
MCPB3029	30	29	17
MCPB3033	30	33	19
MCPB3035	30	35	20
MCPB3041	30	41	25

No upcharge to modify dimensions.

15” High Back Panels

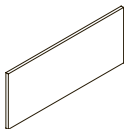

MCPC

MODEL #	WIDTH	HEIGHT	WEIGHT
MCPC3015	30	15	9
MCPC3615	36	15	11
MCPC4215	42	15	13
MCPC4815	48	15	15
MCPC6015	60	15	19
MCPC7215	72	15	24

No upcharge to modify dimensions.

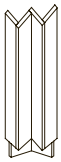
Base Cabinet Corner Filler

MCPE

MODEL #	WIDTH	HEIGHT	WEIGHT
MCPE2429	24	29	9
MCPE2433	24	33	10
MCPE2435	24	35	11
MCPE2441	24	41	12
MCPE3029	30	29	9
MCPE3033	30	33	10
MCPE3035	30	35	11
MCPE3041	30	41	12

No upcharge to modify dimensions.

Wall Cabinet Filler (cont.)

MODEL #	WIDTH	HEIGHT	WEIGHT
MCPH1230	12	30	7
MCPHo436	4	36	5
MCPHo836	8	36	7
MCPH1236	12	36	9
MCPHo442	4	42	6
MCPHo842	8	42	9
MCPH1242	12	42	12

No upcharge to modify dimensions.

Base Cabinet End Filler

MCPF

MODEL #	WIDTH	HEIGHT	WEIGHT
MCPFo429	4	29	3
MCPFo829	8	29	5
MCPF1229	12	29	7
MCPFo433	4	33	4
MCPFo833	8	33	6
MCPF1233	12	33	8
MCPFo435	4	35	5
MCPFo835	8	35	7
MCPF1235	12	35	9
MCPFo441	4	41	6
MCPFo841	8	41	8
MCPF1241	12	41	10

No upcharge to modify dimensions.

Storage Cabinet End Filler

MCPI

MODEL #	WIDTH	HEIGHT	WEIGHT
MCPIo460	4	60	9
MCPIo860	8	60	9
MCPI1260	12	60	9
MCPIo466	4	66	11
MCPIo866	8	66	11
MCPI1266	12	66	11
MCPIo472	4	72	13
MCPIo872	8	72	13
MCPI1272	12	72	13
MCPIo484	4	84	14
MCPIo884	8	84	14
MCPI1284	12	84	14

No upcharge to modify dimensions.

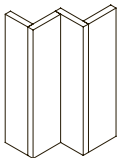
Wall Cabinet Corner Filler

MCPG

MODEL #	WIDTH	HEIGHT	WEIGHT
MCPG1430	14	30	8
MCPG1436	14	36	10
MCPG1442	14	42	12
MCPG1830	18	30	8
MCPG1836	18	36	10
MCPG1842	18	42	12

No upcharge to modify dimensions.

Extended Kick Plate

MCPJ

MODEL #	WIDTH	DEPTH	HEIGHT	WEIGHT
MCPJ3004	30	3/4	4	2
MCPJ3604	36	3/4	4	2
MCPJ4804	48	3/4	4	2
MCPJ6004	60	3/4	4	2
MCPJ7204	72	3/4	4	2
MCPJ8404	84	3/4	4	2

No upcharge to modify dimensions.

Wall Cabinet Filler

MCPH

MODEL #	WIDTH	HEIGHT	WEIGHT
MCPHo418	4	18	3
MCPHo818	8	18	5
MCPH1218	12	18	7
MCPHo424	4	24	3
MCPHo824	8	24	5
MCPH1224	12	24	7
MCPHo430	4	30	3
MCPHo830	8	30	5

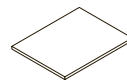
Adjustable Shelves for Cabinets

MCPS

DESCRIPTION	WEIGHT
Shelf options should be added at the end of the model #.	
Choose B for Base cab	15
Choose S for Storage cab	15
Choose W for Wall cab	15
Choose D for Double Sided Bookcase	15
Choose P for Pass thru Cab	15
Choose M for Mobile Island	15

Upper Fascia Top



MCAF

MODEL #	WIDTH	DEPTH	HEIGHT	WEIGHT
MCAF1214	12	3/4	14	4
MCAF1224	12	3/4	24	5
MCAF1514	15	3/4	14	5
MCAF1524	15	3/4	24	6
MCAF1814	18	3/4	14	6
MCAF1824	18	3/4	24	8
MCAF2114	21	3/4	14	7
MCAF2124	21	3/4	24	10
MCAF2414	24	3/4	14	8
MCAF2424	24	3/4	24	11
MCAF3014	30	3/4	14	10
MCAF3024	30	3/4	24	12
MCAF3314	33	3/4	14	11
MCAF3324	33	3/4	24	13
MCAF3614	36	3/4	14	12
MCAF3624	36	3/4	24	16
MCAF3914	39	3/4	14	13
MCAF3924	39	3/4	24	17
MCAF4214	42	3/4	14	14
MCAF4224	42	3/4	24	18
MCAF4514	45	3/4	14	15
MCAF4524	45	3/4	24	19
MCAF4814	48	3/4	14	16
MCAF4824	48	3/4	24	21
MCAF5114	51	3/4	14	17
MCAF5124	51	3/4	24	22
MCAF5414	54	3/4	14	18
MCAF5424	54	3/4	24	23
MCAF5714	57	3/4	14	19
MCAF5724	57	3/4	24	25
MCAF6014	60	3/4	14	20
MCAF6024	60	3/4	24	26
MCAF6314	63	3/4	14	21
MCAF6324	63	3/4	24	27
MCAF6614	66	3/4	14	22
MCAF6624	66	3/4	24	28
MCAF6914	69	3/4	14	23
MCAF6924	69	3/4	24	30
MCAF7214	72	3/4	14	24
MCAF7224	72	3/4	24	31
MCAF7514	75	3/4	14	25
MCAF7524	75	3/4	24	32
MCAF7814	78	3/4	14	26
MCAF7824	78	3/4	24	34
MCAF8114	81	3/4	14	27
MCAF8124	81	3/4	24	35
MCAF8414	84	3/4	14	28
MCAF8424	84	3/4	24	36
MCAF8714	87	3/4	14	29

Upper Fascia Top (cont.)

MODEL #	WIDTH	DEPTH	HEIGHT	WEIGHT
MCAF8724	87	3/4	24	37
MCAF9014	90	3/4	14	30
MCAF9024	90	3/4	24	39
MCAF9314	93	3/4	14	31
MCAF9324	93	3/4	24	40
MCAF9614	96	3/4	14	32
MCAF9624	96	3/4	24	42
MCAF10814	108	3/4	14	36
MCAF10824	108	3/4	24	47

No upcharge to modify dimensions.

Angled Tops for Storage Cabinets



MCAS

MODEL #	WIDTH	DEPTH	HEIGHT	WEIGHT
MCAS1218	12	18	3/4	5
MCAS1518	15	18	3/4	6
MCAS1818	18	18	3/4	8
MCAS2118	21	18	3/4	10
MCAS2418	24	18	3/4	11
MCAS3018	30	18	3/4	12
MCAS3318	33	18	3/4	13
MCAS3618	36	18	3/4	16
MCAS3918	39	18	3/4	17
MCAS4218	42	18	3/4	18
MCAS4518	45	18	3/4	19
MCAS4818	48	18	3/4	21
MCAS5118	51	18	3/4	22
MCAS5418	54	18	3/4	23
MCAS5718	57	18	3/4	25
MCAS6018	60	18	3/4	26
MCAS6318	63	18	3/4	27
MCAS6618	66	18	3/4	28
MCAS6918	69	18	3/4	30
MCAS7218	72	18	3/4	31
MCAS7518	75	18	3/4	32
MCAS7818	78	18	3/4	34
MCAS8118	81	18	3/4	35
MCAS8418	84	18	3/4	36
MCAS8718	87	18	3/4	37
MCAS9018	90	18	3/4	39
MCAS9318	93	18	3/4	40
MCAS9618	96	18	3/4	42
MCAS10818	108	18	3/4	48

No upcharge to modify dimensions.

Specify length. Add all width dimensions of storage cabinets to determine angled tops' length. Call if angled tops exceed 9 feet in length.

Angled Tops for Wall Cabinets

MODEL #	WIDTH	DEPTH	HEIGHT	WEIGHT
MCAW1214	12	14	3/4	4
MCAW1218	12	18	3/4	5
MCAW1514	15	14	3/4	5
MCAW1518	15	18	3/4	6
MCAW1814	18	14	3/4	6
MCAW1818	18	18	3/4	8
MCAW2114	21	14	3/4	7
MCAW2118	21	18	3/4	10
MCAW2414	24	14	3/4	8
MCAW2418	24	18	3/4	11
MCAW3014	30	14	3/4	10
MCAW3018	30	18	3/4	12
MCAW3314	33	14	3/4	11
MCAW3318	33	18	3/4	13
MCAW3614	36	14	3/4	12
MCAW3618	36	18	3/4	16
MCAW3914	39	14	3/4	13
MCAW3918	39	18	3/4	17
MCAW4214	42	14	3/4	14
MCAW4218	42	18	3/4	18
MCAW4514	45	14	3/4	15
MCAW4518	45	18	3/4	19
MCAW4814	48	14	3/4	16
MCAW4818	48	18	3/4	21
MCAW5114	51	14	3/4	17
MCAW5118	51	18	3/4	22
MCAW5414	54	14	3/4	18
MCAW5418	54	18	3/4	23
MCAW5714	57	14	3/4	19
MCAW5718	57	18	3/4	25
MCAW6014	60	14	3/4	20
MCAW6018	60	18	3/4	26
MCAW6314	63	14	3/4	21
MCAW6318	63	18	3/4	27
MCAW6614	66	14	3/4	22
MCAW6618	66	18	3/4	28
MCAW6914	69	14	3/4	23
MCAW6918	69	18	3/4	30
MCAW7214	72	14	3/4	24
MCAW7218	72	18	3/4	31
MCAW7514	75	14	3/4	25
MCAW7518	75	18	3/4	32
MCAW7814	78	14	3/4	26
MCAW7818	78	18	3/4	34
MCAW8114	81	14	3/4	27
MCAW8118	81	18	3/4	35
MCAW8414	84	14	3/4	28
MCAW8418	84	18	3/4	36
MCAW8714	87	14	3/4	29

Angled Tops for Wall Cabinets (cont.)

MODEL #	WIDTH	DEPTH	HEIGHT	WEIGHT
MCAW8724	87	3/4	24	37
MCAW9014	90	3/4	14	30
MCAW9024	90	3/4	24	39
MCAW9314	93	3/4	14	31
MCAW9324	93	3/4	24	40
MCAW9614	96	3/4	14	32
MCAW9624	96	3/4	24	42
MCAW10814	108	3/4	14	36
MCAW10824	108	3/4	24	47

No upcharge to modify dimensions.

Specify length. Add all width dimensions of wall cabinets to determine angled tops' length. Call if angled tops exceed 9 feet in length.

CPU Strap



MCPT

MODEL #	WIDTH	DEPTH	HEIGHT	WEIGHT
MCPT0511	4 3/4	11	1 4/5	10

Cable Cut Out and Round Grommet with Cover



MRCBLCO-3

MODEL #	WIDTH	WEIGHT
MRCBLCO-3	2 3/8	1

Adjustable Keyboard Tray

MODEL #	WEIGHT
MRKDADJ	15
MRKDADJM (with mouse)	16

Paper Slot with Oval Grommet

MODEL #	WIDTH	HEIGHT	WEIGHT
MRSLOT-10	10	1 1/2	1
MRSLOT-13	13	2	1

Task Lighting

MODEL #	WIDTH	DEPTH	HEIGHT
MRUSTL-24	18	7	1 1/2

Selecting the Sorter Shelves Accessories

HAMILTON's unique shelving systems provides easy shelf adjustability in 1" increments on full depth shelf supports and are available in Standard (for 8½" x 11" documents) Legal (for 8½" x 14" documents) or Oversize (for large forms up to 12¾" w x 15" d).

Shelf Supports are made of durable plastic available in Black, Brown, Gray and Transparent.

RMSxx Shelves are made from a flexible .90-gauge polyethylene plastic and are rated to hold up to 35 lbs and are available in Black, Brown, Gray and Transparent.

WRMSxx Shelves are made of 5/8" thick laminate and are rated to hold up to 50 lbs and are available in any of our standard laminates and edge banding.

All shelves have full width index channels, both front and rear; and the indexing is protected with a clear index cover.

INDX-x Color Coded Index Strips come 18 strips per sheet and are available in 10 colors:

Green	Light Green
Magenta	Electric Yellow
Canary	Blue
Orange	White
Gold	Electric Pink

When ordering HAMILTON base, wall cabinets and shelves a mixture of colors will be selected. If you would like a specific color please specify.

Indexing Templates (in word) are downloadable free of charge at www.hamiltoncs.com, or contact Customer Service at 800.503.9966 for more information.

Sorter Shelf Products

Sorter Shelves

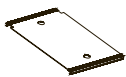

Shelves available in gray, black, brown, and transparent

MODEL #	DESCRIPTION	WIDTH	DEPTH	WEIGHT
RMS10	Standard Size	10¾	11¾	1
RMS10-5	Standard Size 5-pk	10¾	11¾	3
WRMS10	Std. Size Laminate	10¾	11¾	2
RMS14	Legal Size	10¾	15¾	1
RMS14-5	Legal Size 5-pk	10¾	15¾	3
WRMS14	Leg. Size Laminate	10¾	15¾	2
RMS12	Over Size	12¾	15¾	1
RMS12-5	Over Size- 5-pk	12¾	15¾	3
WRMS12	Over Size Laminate	12¾	15¾	2

Indexing

MODEL #	DESCRIPTION
INDX-S	10 sheets of indexing for Standard and Legal
INDX-O	10 sheets of indexing for Oversize

Standard Handles

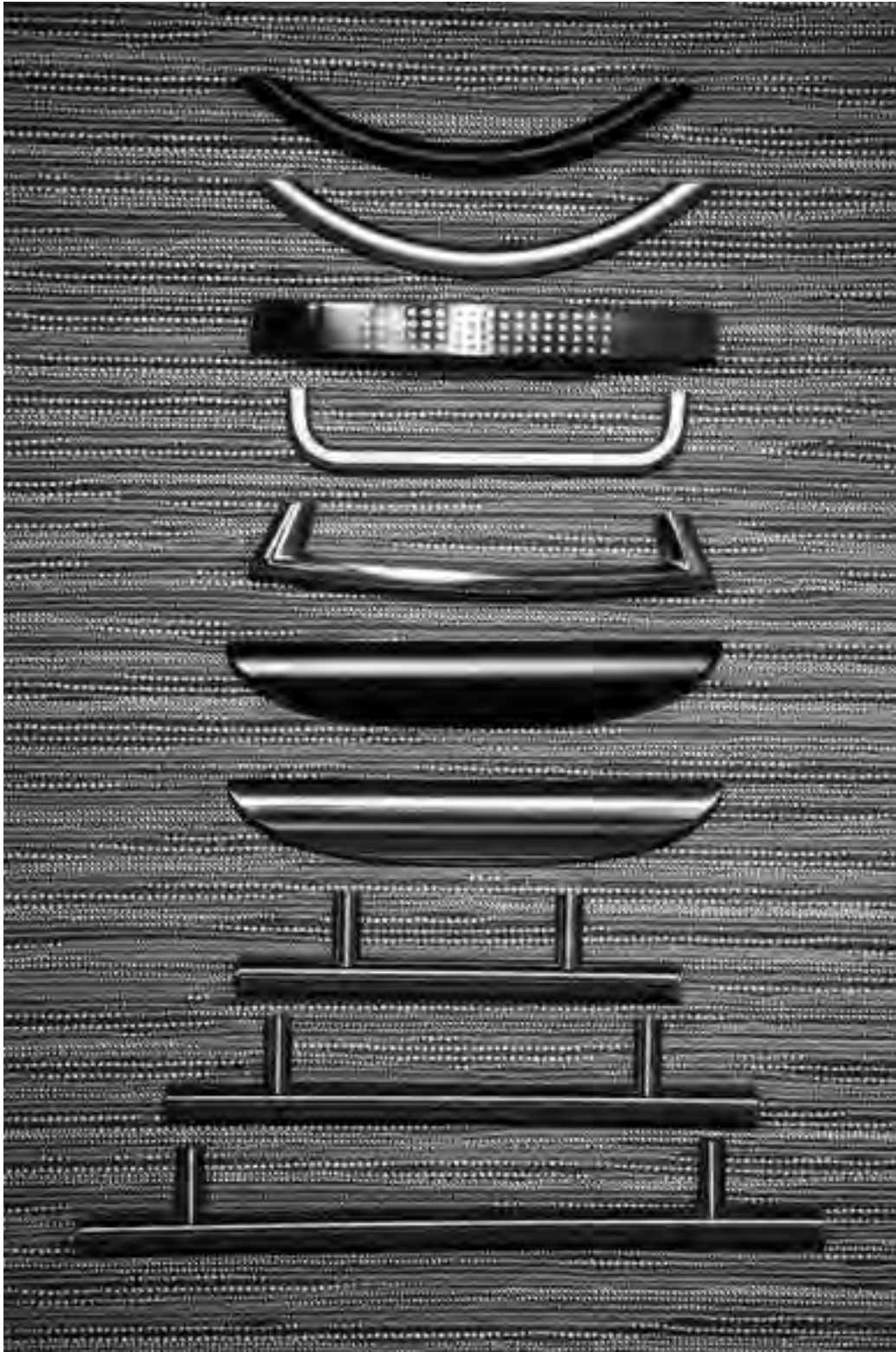

Standard Laminate Colors

	Color Number	Work Surface	Base and Verticals	Edge Banding	Thermofoil	Brand Name and Number
Antique White	013	●	●	●	●	Wilsonart 1572-60
Black	007	●	●	●	●	Wilsonart 1595-60
Cafelle	099	●	●	●	●	Wilsonart 7933T-07
Canyon Zephyr	093	●	●	●		Wilsonart 4842-60
Cognac	091	●	●	●	●	Nevamar Dynea 4511
Colombian Walnut	102	●	●	●		Wilsonart 7943 K
Desert Zephyr	095	●				Wilsonart 4841-60
Designer White	082	●	●	●	●	Wilsonart D354-60
Dove Grey	002	●	●	●		Wilsonart D92-60
Empire Mahogany	078	●	●	●		Wilsonart 7122T-60
Fashion Grey	035	●	●	●	●	Wilsonart D381-60
Frosty White	071	●	●	●	●	Wilsonart 1573-60
Graphite Nebula	030	●	●	●		Wilsonart 4623-60
Grey Moss	090	●	●	●		Wilsonart 15008
Ingot Grey	006	●	●	●		Pionite SG211-S
Kensington Maple	036	●	●	●	●	Wilsonart 10776-60
Misted Zephyr	094	●				Wilsonart 4843-60
Monticello Maple	101	●	●	●		Wilsonart 7925
Natural Almond	031	●	●	●	●	Wilsonart D30-60
Oiled Cherry	055	●	●	●		Pionite WC421-S
Shadow	096	●	●	●		Wilsonart D96-60
Shaker Cherry	097	●	●	●	●	Wilsonart 7935-7
Slate Grey	068	●	●	●		Wilsonart D91-60
Solar Oak	089	●	●	●	●	Wilsonart 7816-60
Twilight Zephyr	092	●				Wilsonart 4845-60
White Nebula	086	●				Wilsonart 4621-60
Windsor Mahogany	001	●	●	●		Wilsonart 7039-60
Woodlawn Cherry	003	●	●	●	●	Uniboard 965

Limited Lifetime Warranty

Hamilton Casework Solutions (“HAMILTON”) warrants to the original retail purchaser that HAMILTON Products purchased on or after January 1, 1996 will be free from defects in material and workmanship for as long as the original retail purchaser owns such HAMILTON Product, except for the following, which are warranted only as to the HAMILTON Product components of the items (HAMILTON expressly disclosing any warranty, express or implied, on hardware, electronics or other specialty components specified by a HAMILTON customer but not manufactured by HAMILTON) and for a period of three years from the date of purchase as shown on the HAMILTON Sales Order: Tack board fabric, task lights, casters, carts, adjustable keyboards and module shelf standard as well as any powder coated item. This warranty is made solely to the original retail purchaser, is non-transferable and shall be effective from the date of purchase as shown on the HAMILTON Sales Order. This warranty is void for any damages to the HAMILTON Product due to misuse, abuse, neglect, accident, improper installation, failure to comply with instructions furnished by HAMILTON or any repair or alteration performed by anyone other than HAMILTON or an authorized HAMILTON dealer. Damage caused by common carrier during shipment is not included in this warranty.

THIS FOREGOING WARRANTY IS IN LIEU OF, AND HAMILTON EXPRESSLY DISCLAIMS ALL OTHER, WARRANTIES OF ANY KIND, EXPRESS OR IMPLIED. IN NO EVENT SHALL HAMILTON BE LIABLE TO ANY RETAIL PURCHASER OR USER OF HAMILTON PRODUCTS OR ANY THIRD PARTY FOR CONSEQUENTIAL, INDIRECT, INCIDENTAL, SPECIAL, EXEMPLARY, PUNITIVE OR ENHANCED DAMAGES, LOST PROFITS OR REVENUES OR DIMINUTION IN VALUE ARISING OUT OF THE PURCHASE, SALE OR USE OF HAMILTON PRODUCTS, REGARDLESS OF WHETHER SUCH DAMAGES WERE FORSEEABLE, WHETHER OR NOT HAMILTON WAS ADVISED OF THE POSSIBILITY OF SUCH DAMAGES AND THE LEGAL OR EQUITABLE THEORY ON WHICH THE CLAIM IS MADE.

Hamilton Casework Solutions offer GREENGUARD Gold certified products to provide safe, quality, environmentally friendly workspaces. FSC and OSHPD certified components are also available as specified by a designer.