



fume hoods



cabinets



tables

Our success stems from our ability & dedication to understand and react to the changing needs of our clients. We carefully monitor and control your project from concept to completion. Our experienced sales engineers can help identify your project needs & time constraints.

The layout and design of your new lab space will lead to a host of questions from us that will help insure the quality & flow of the finished product. The lab programming function will determine where all of your equipment will be placed within the lab to confirm that the correct services & ventilation will be provided. Our factory trained and authorized installation force will complete the link to a finished and approved project. Our goal is to create a new or renovated lab environment that will meet your needs now and into the future.

We have an excellent selection of painted steel cabinets, stainless steel cabinets, fume hoods and work surfaces available. We are a full service manufacturer for all your laboratory furniture needs. Call one of our professionals for a sales consultation.

contents:

Note: This is an abbreviated product offering

| | |
|---|----|
| cabinet construction detail..... | 2 |
| standing height cabinets..... | 3 |
| sitting height cabinets..... | 5 |
| ADA height, tall storage & wall cabinets..... | 6 |
| tables, fillers & scribes..... | 7 |
| fume hoods..... | 8 |
| work surfaces & wall shelving..... | 11 |
| island shelving and racking systems..... | 12 |
| fixtures..... | 13 |
| sinks & pegboards..... | 14 |



Cabinet Construction Detail

Our cabinets are made from heavy gauge steel. They are fully welded and constructed for decades of performance. Base units have a load capacity of 500 lbs per linear foot. Our environmentally friendly powder coat finish, available in seventeen designer colors, helps to create a comfortable and practical lab environment. All cabinets are also available in a stainless steel construction. We bring quality, durability and beauty to your laboratory.

Steel Cabinet Construction

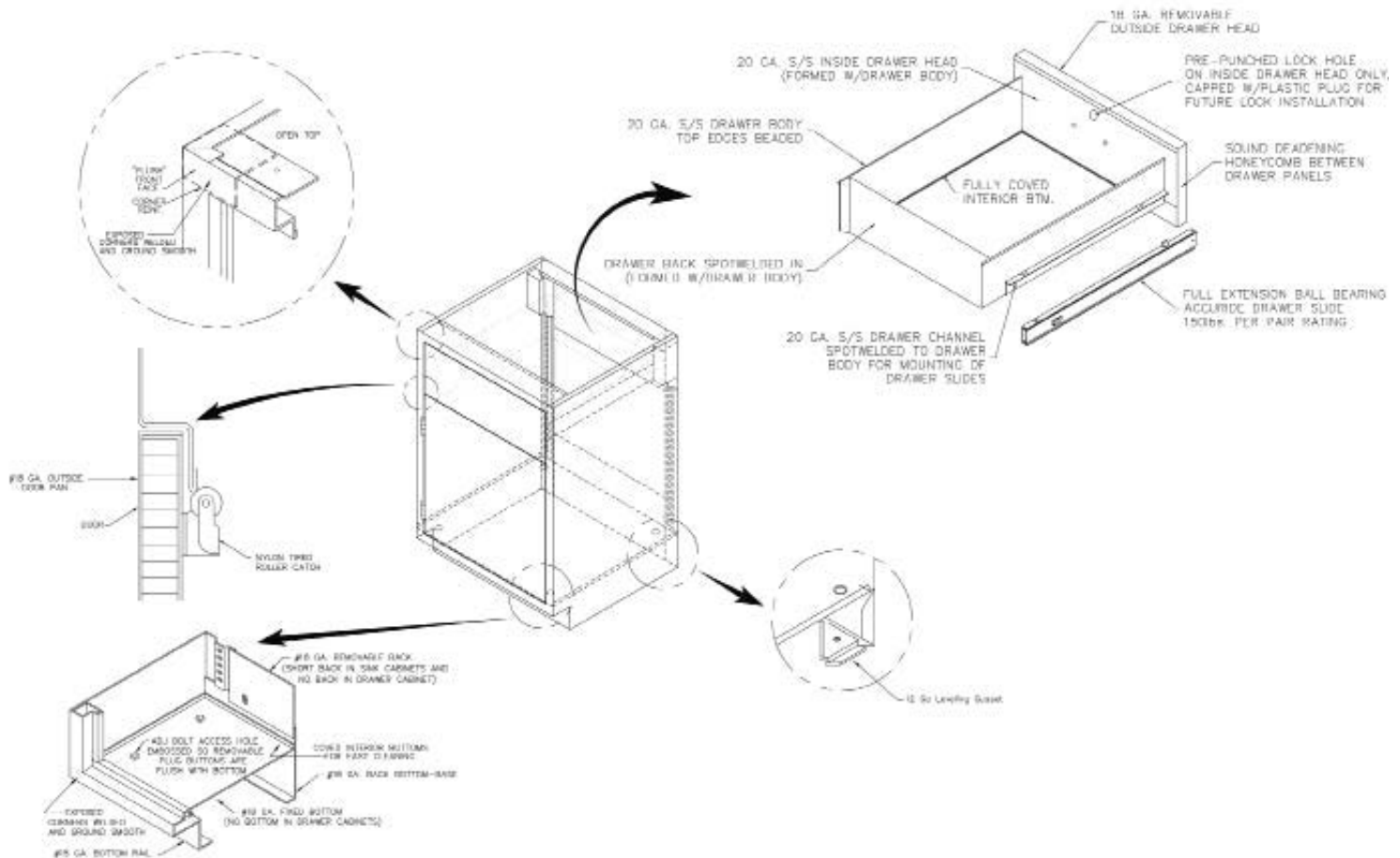

Cabinet Bottom & Base

- Completely enclosed toe space promotes lab cleanliness
- Lower corner reinforcing gusset with 2-1/2" height leveling bolt (full four corners)

Customizing

- Special cabinet dimensions and features are no problem
- Powder coated steel available in 17 colors. Will match any custom color
- Host of pulls available

Steel Door

- Two piece door construction
- Structurally sound deadened for added strength and quiet operation
- Five knuckle institutional type stainless steel hinge
- Positive plunger catch
- Rubber door bumpers

Steel Drawer

- One piece, type 304 stainless steel drawer body with radiused bottom for easy cleaning
- Full extension ball bearing Accuride drawer suspension provides 150 lbs load capacity
- Drawer head is sound deadened for quiet operation

Standing Height Base Cabinets

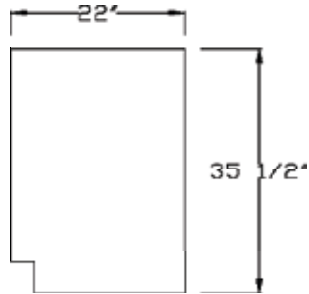

Standing Height Side View

Specifications:
Standing height cabinets are 35.5" high and 22" deep. Lengths are shown.

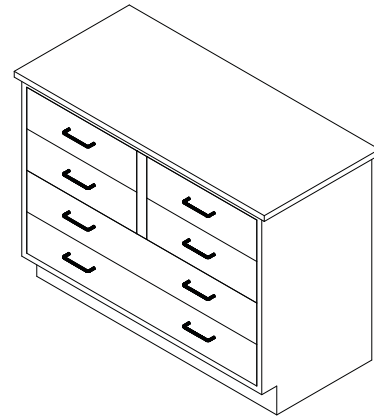

- P106 - 30 ___ 30" L
- P106 - 36 ___ 36" L
- P106 - 42 ___ 42" L
- P106 - 48 ___ 48" L

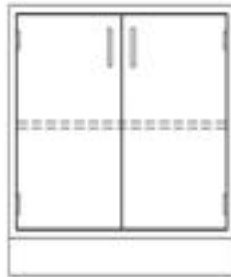

- P103 - 30 ___ 30" L
- P103 - 36 ___ 36" L
- P103 - 42 ___ 42" L
- P103 - 48 ___ 48" L



- P121 - 30 ___ 30" L
- P121 - 36 ___ 36" L
- P121 - 42 ___ 42" L
- P121 - 48 ___ 48" L



- P124 - 30 ___ 30" L
- P124 - 36 ___ 36" L
- P124 - 42 ___ 42" L
- P124 - 48 ___ 48" L



- P110 - 30 ___ 30" L
- P110 - 36 ___ 36" L
- P110 - 42 ___ 42" L
- P110 - 48 ___ 48" L



- P113 - 30 ___ 30" L
- P113 - 36 ___ 36" L
- P113 - 42 ___ 42" L
- P113 - 48 ___ 48" L



- P108 - 30 ___ 30" L
- P108 - 36 ___ 36" L
- P108 - 42 ___ 42" L
- P108 - 48 ___ 48" L



- P181 - 30 ___ 30" L
- P181 - 36 ___ 36" L
- P181 - 42 ___ 42" L
- P181 - 48 ___ 48" L
- P181 - 52 ___ 52" L

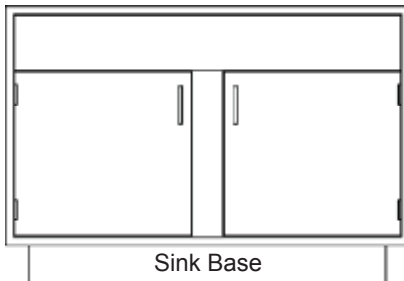

- P186 - 52 ___ 52" L
- P186 - 58 ___ 58" L
- P186 - 60 ___ 60" L



- P190 - 32 ___ 32" L

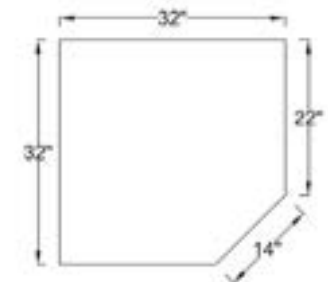

Corner Cabinet Plan View

Standing Height Base Cabinets

Specifications:
Standing height cabinets are 35.5" high and 22" deep. Lengths are shown.



P195 - 15 ___ 15" L
P195 - 18 ___ 18" L
P195 - 21 ___ 21" L
P195 - 24 ___ 24" L

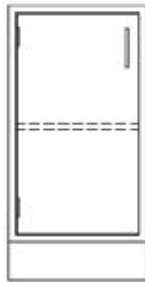

P196 - 15 ___ 15" L
P196 - 18 ___ 18" L
P196 - 21 ___ 21" L
P196 - 24 ___ 24" L



P118 - 15 ___ 15" L
P118 - 18 ___ 18" L
P118 - 21 ___ 21" L
P118 - 24 ___ 24" L

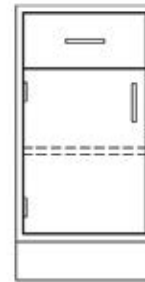

P119 - 15 ___ 15" L
P119 - 18 ___ 18" L
P119 - 21 ___ 21" L
P119 - 24 ___ 24" L



P122 - 15 ___ 15" L
P122 - 18 ___ 18" L
P122 - 21 ___ 21" L
P122 - 24 ___ 24" L

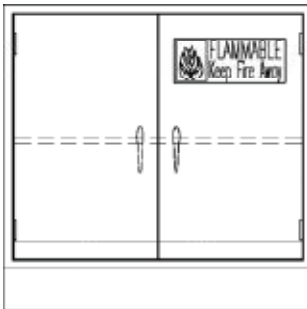

Flammable Cabinet*
P189 - 30 ___ 30" L
P189 - 36 ___ 36" L
P189 - 48 ___ 48" L

*Note: These cabinets carry a UL rating



Acid Cabinet *
P188 - 30 ___ 30" L
P188 - 36 ___ 36" L
P188 - 42 ___ 42" L
P188 - 48 ___ 48" L

*Note: Doors & cabinet interiors have an acid resistant liner

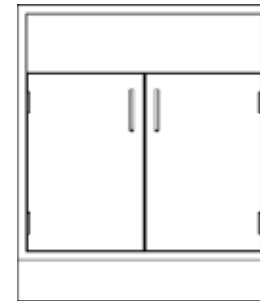

Fume Hood Cabinet
P187 - 30 ___ 30" L
P187 - 36 ___ 36" L
P187 - 42 ___ 42" L
P187 - 48 ___ 48" L
P187 - 60 ___ 60" L

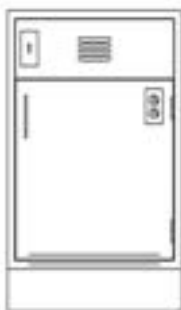

Vacuum Pump Cabinet
Sound Deadened
with Interior Receptacle
P177 - 18 ___ 18" L
P177 - 21 ___ 21" L
P177 - 24 ___ 24" L



1 Drawer Apron
22" Deep
Furnished as needed with knee space panels

TBA - 2422 - 1 ___ 24" L
TBA - 3022 - 1 ___ 30" L
TBA - 3622 - 1 ___ 36" L
TBA - 4222 - 1 ___ 42" L
TBA - 4822 - 1 ___ 48" L
TBA - 5422 - 1 ___ 54" L
TBA - 6022 - 1 ___ 60" L



TPL - 3522 ___ 2" L
22" Deep Pedestal Leg

Sitting Height Base Cabinets

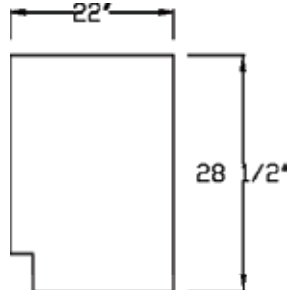

Sitting Height Side View

Specifications:
Sitting height cabinets are 28.5" high and 22" deep. Lengths are shown.

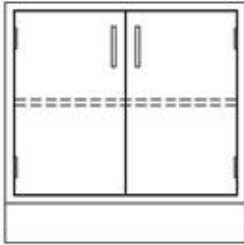
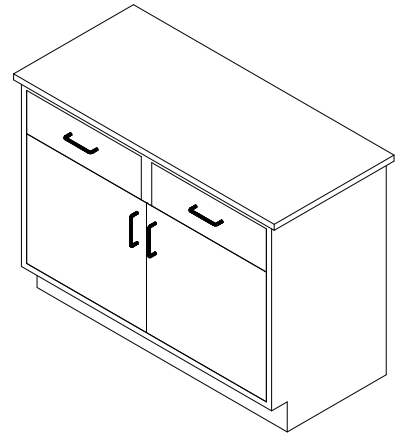

P163 - 30 ___ 30" L
P163 - 36 ___ 36" L
P163 - 42 ___ 42" L
P163 - 48 ___ 48" L

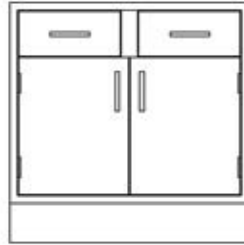

P166 - 30 ___ 30" L
P166 - 36 ___ 36" L
P166 - 42 ___ 42" L
P166 - 48 ___ 48" L

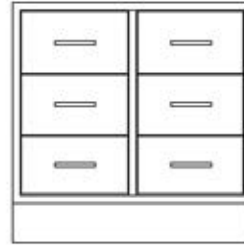

P178 - 30 ___ 30" L
P178 - 36 ___ 36" L
P178 - 42 ___ 42" L
P178 - 48 ___ 48" L

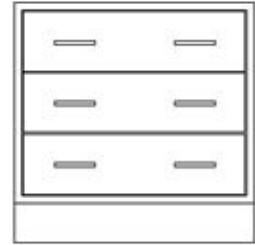

P174 - 30 ___ 30" L
P174 - 36 ___ 36" L
P174 - 42 ___ 42" L
P174 - 48 ___ 48" L



P071 - 15 ___ 15" L
P071 - 18 ___ 18" L
P071 - 21 ___ 21" L
P071 - 24 ___ 24" L



P174 - 15 ___ 15" L
P174 - 18 ___ 18" L
P174 - 21 ___ 21" L
P174 - 24 ___ 24" L



P172 - 15 ___ 15" L
P172 - 18 ___ 18" L
P172 - 21 ___ 21" L
P172 - 24 ___ 24" L

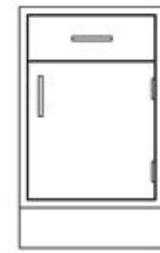

P168 - 15 ___ 15" L
P168 - 18 ___ 18" L
P168 - 21 ___ 21" L
P168 - 24 ___ 24" L

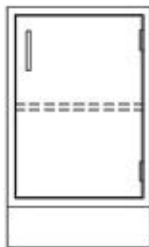

P175 - 15 ___ 15" L
P175 - 18 ___ 18" L
P175 - 21 ___ 21" L
P175 - 24 ___ 24" L

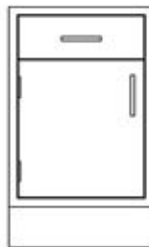

P169 - 15 ___ 15" L
P169 - 18 ___ 18" L
P169 - 21 ___ 21" L
P169 - 24 ___ 24" L



P161 - 15 ___ 15" L
P161 - 18 ___ 18" L
P161 - 21 ___ 21" L
P161 - 24 ___ 24" L



TPL-2822 ___ 2" L
22" Deep Pedestal Leg

ADA Height, Wall Cabinets & Tall Storage Cabinets

Specifications:
 ADA Height Cabinets are 32.5" high
 and 22" deep. Lengths are shown.

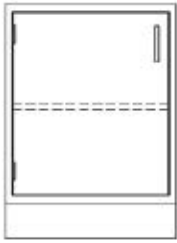
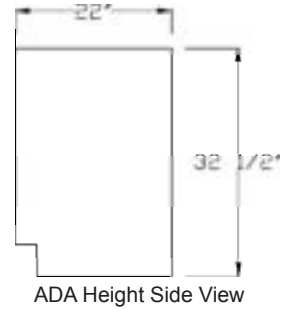

P996 - 15 ___ 15" L
 P996 - 18 ___ 18" L
 P996 - 21 ___ 21" L
 P996 - 24 ___ 24" L

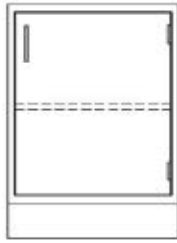

P995 - 15 ___ 15" L
 P995 - 18 ___ 18" L
 P995 - 21 ___ 21" L
 P995 - 24 ___ 24" L

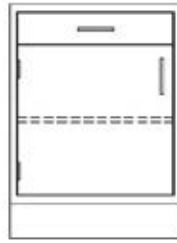

P933 - 15 ___ 15" L
 P933 - 18 ___ 18" L
 P933 - 21 ___ 21" L
 P933 - 24 ___ 24" L

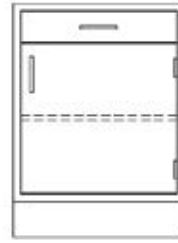

P932 - 15 ___ 15" L
 P932 - 18 ___ 18" L
 P932 - 21 ___ 21" L
 P932 - 24 ___ 24" L



P928 - 15 ___ 15" L
 P928 - 18 ___ 18" L
 P928 - 21 ___ 21" L
 P928 - 24 ___ 24" L

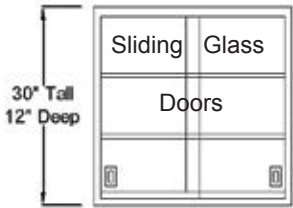

P219 - 30 ___ 30" L
 P219 - 36 ___ 36" L
 P219 - 42 ___ 42" L
 P219 - 48 ___ 48" L



P208 - 30 ___ 30" L
 P208 - 36 ___ 36" L
 P208 - 42 ___ 42" L
 P208 - 48 ___ 48" L



P206 - 30 ___ 30" L
 P206 - 36 ___ 36" L
 P206 - 42 ___ 42" L
 P206 - 48 ___ 48" L

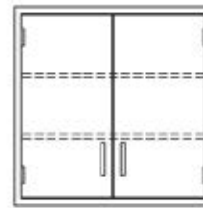

P203 - 30 ___ 30" L
 P203 - 36 ___ 36" L
 P203 - 42 ___ 42" L
 P203 - 48 ___ 48" L

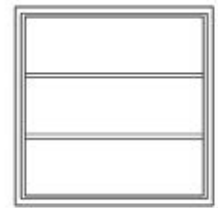

P201 - 30 ___ 30" L
 P201 - 36 ___ 36" L
 P201 - 42 ___ 42" L
 P201 - 48 ___ 48" L

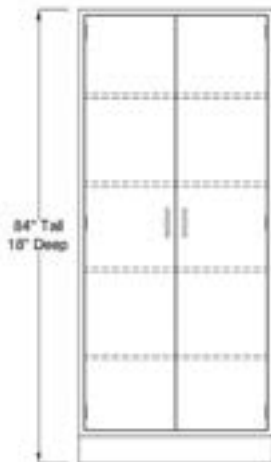

P332 - 30 ___ 30" L
 P332 - 36 ___ 36" L
 P332 - 42 ___ 42" L
 P332 - 48 ___ 48" L



P335 - 30 ___ 30" L
 P335 - 36 ___ 36" L
 P335 - 42 ___ 42" L
 P335 - 48 ___ 48" L



P337 - 30 ___ 30" L
 P337 - 36 ___ 36" L
 P337 - 42 ___ 42" L
 P337 - 48 ___ 48" L



P338 - 30 ___ 30" L
 P338 - 36 ___ 36" L
 P338 - 42 ___ 42" L
 P338 - 48 ___ 48" L

Heavy Duty Tubular Steel Tables

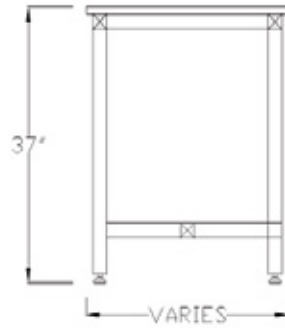

Side View of Table

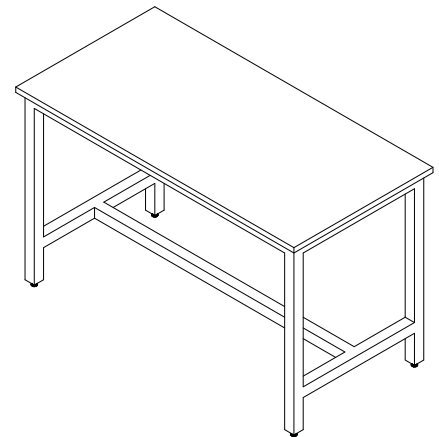

Specifications:

Laboratory Tables are an integral part of lab flexibility and mobility. We have many standard sizes and can create most any custom configuration. Tables are constructed from 2" x 2" painted tubular steel. Tables come standard with nylon leveling feet. Table work surfaces must be ordered separately.

Options Available:

- 4" Locking swivel casters
- Heavy duty leveling casters
- Mobile storage cabinets
- Lower shelving
- Adjustable height feature

| Table Width | 24" Deep | 30" Deep | 36" Deep | 48" Deep |
|-------------|----------|----------|----------|----------|
| 48" | LB243648 | LB303648 | LB363648 | LB483648 |
| 60" | LB243660 | LB303660 | LB363660 | LB483660 |
| 72" | LB243672 | LB303672 | LB363672 | LB483672 |
| 96" | LB243696 | LB303696 | LB363696 | LB483696 |

Fillers & Scribes

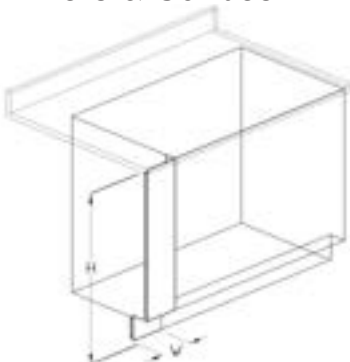

End Scribe

Sitting Height - 29" High

| | |
|-----------|------------|
| FFL - 01 | 1" W |
| FFL - 02 | 2" W |
| FFL - 06 | 6" W |
| FFL - 08 | 8" W |
| FFL - ADJ | Adjustable |

Standing Height - 35" High

| | |
|-----------|------------|
| FFH - 01 | 1" W |
| FFH - 02 | 2" W |
| FFH - 06 | 6" W |
| FFH - 08 | 8" W |
| FFH - ADJ | Adjustable |

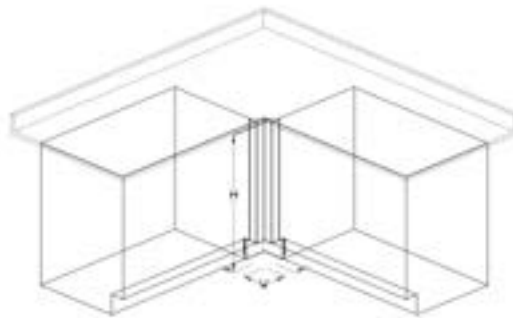

Corner Filler

Sitting Height - 29" High

| | |
|----------|------|
| FCL - 01 | 1" W |
| FCL - 02 | 2" W |
| FCL - 03 | 3" W |
| FCL - 04 | 4" W |

Standing Height - 35" High

| | |
|----------|------|
| FCH - 01 | 1" W |
| FCH - 02 | 2" W |
| FCH - 03 | 3" W |
| FCH - 04 | 4" W |

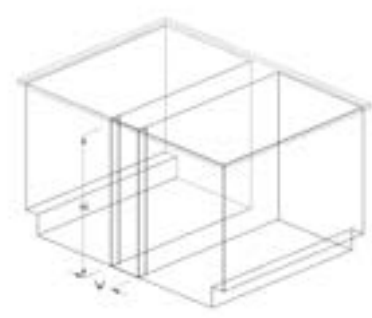

Pipe Chase Filler

Sitting Height - 29" High

| | |
|-----------|------------|
| FRL - 01 | 1" W |
| FRL - 02 | 2" W |
| FRL - 04 | 4" W |
| FRL - 07 | 7" W |
| FRL - 08 | 8" W |
| FRL - 14 | 14" W |
| FRL - 20 | 20" W |
| FRL - ADJ | Adjustable |

Standing Height - 35" High

| | |
|-----------|------------|
| FRH - 01 | 1" W |
| FRH - 02 | 2" W |
| FRH - 04 | 4" W |
| FRH - 07 | 7" W |
| FRH - 08 | 8" W |
| FRH - 14 | 14" W |
| FRH - 20 | 20" W |
| FRH - ADJ | Adjustable |

Chemical Bench Fume Hoods

With Vertical Rising Sash



Chain Driven Sash
for smooth operation includes a
lifetime warranty.



Standard Features:

- 28" Sash opening
- 41" Tall full view sash area
- Chain driven sash assures easy, smooth sash operation
- Powder coated steel exterior
- White chemically resistant Polyglass liner
- Stainless steel duct collar
- Two pre-wired 120V 20amp duplex receptacles
- One pre-wired 20 amp light switch
- Pre-wired vapor tight T8 fluorescent light fixture
- Radiused corner posts and airfoils for smooth, safe and efficient air movement
- 5" thick end walls provide more interior work space
- Interior baffles designed to optimize containment & minimized turbulence
- Tempered glass sash with full-length formed steel handle for a neat, clean appearance and streamline air passage
- Large interior access panels provide easy access to piping and service fittings
- Heavy gauge cold rolled steel exterior panels with independent rigid structural frame
- Designed and tested to ASHRAE 110-1995 standards
- UL 1805 classified
- Each hood side post and interior is punched and plugged to receive 5 service fixtures

Options Available:

- Smart-Sash, automatic sash operator
- Air Flow and static pressure alarms
- Special heights & depths
- Service fittings and piping
- Ceiling enclosure
- Tissue Screen
- Distillation Rack
- Sash Stop
- Epoxy resin, stainless steel, PVC & Polyglass hood liners
- 220V electrical
- Remote exhaust fans
- Explosion proof electrical and lights

Additional Styles of Hoods Available:

- | | |
|--------------------|-------------------|
| • High Performance | • Perchloric Acid |
| • Combination Sash | • Radio Isotope |
| • Split Sash | • ADA |
| • Walk-in | • Distillation |

Chemical Bench Fume Hoods

With Vertical Rising Sash

Specifications:

Our GEN 5 chemical fume hoods are designed to capture, contain and vent toxic and noxious fumes away from the user providing a safe and secure lab work environment. These hoods are furnished with a choice of liner and baffles with upper, center and lower exhaust slots. Each fume hood is furnished complete with a lower deflector vane, counter balanced chain driven sash of 1/4" tempered glass and removable interior plumbing access panels. All exterior steel components are painted via an environmentally friendly, electrostatically applied powder coat process. The exhaust duct collars are made from stainless steel. Our hoods are available with either an Open By-Pass or a Restricted By-Pass for VAV use.

| Isolator GEN5 Model Number | Overall Hood Length | Round Duct Diameter | Sash Opening Area (Sq Ft) | Total CFM & Static Pressure | |
|----------------------------|---------------------|---------------------|---------------------------|-----------------------------|-----------|
| | | | | @ 100 FPM | S.P. Loss |
| F-100-48G5 | 4'-0" | 10" | 7.4 | 740 | 0.32" |
| F-100-60G5 | 5'-0" | 12" | 9.7 | 972 | 0.27" |
| F-100-72G5 | 6'-0" | 12" | 12.0 | 1,205 | 0.41" |
| F-100-96G5 | 8'-0" | 10" x 2 | 16.7 | 1,672 | 0.41" |

Static pressures shown are for the pressure drop through the hoods only. The total pressure drop through the hood and the duct system must be calculated to select the proper exhaust fan.

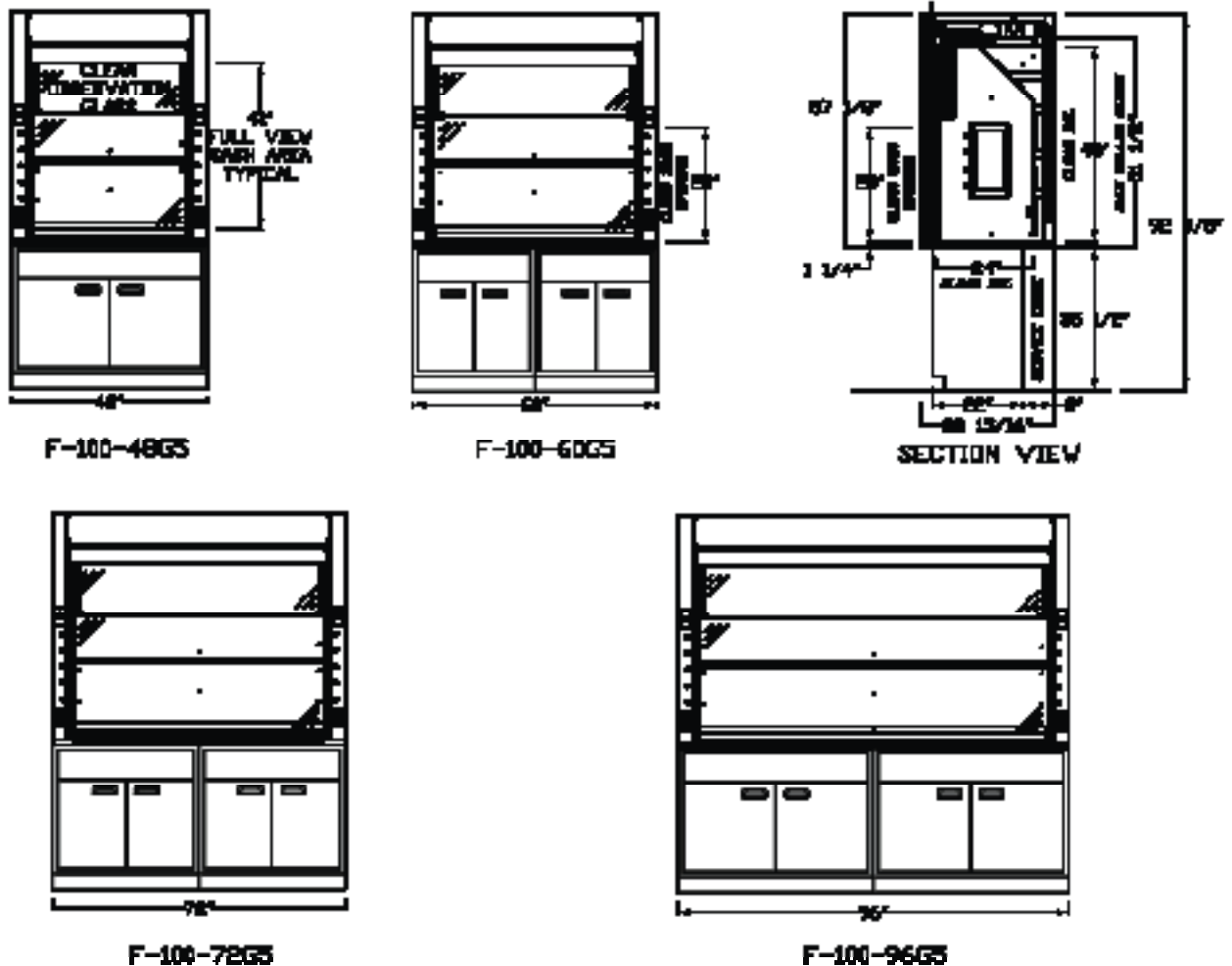

Fume Hood Accessories

Fittings for Bench Hoods



These WaterSaver brand remote control fittings consist of a brass angle valve with a replaceable seat, a nylon color-coded panel flange with angle serrated hose connector (Except GS-3185-WV, which features a gooseneck with vacuum breaker), a remote control rod assembly with a plastic angle flange, and a tank nipple, lock-nut, and washer.

Fittings may be used on either side of the hood.

| Fitting Type | Cat. No. |
|--|-------------|
| Air | LGS-3185-A |
| Cold Water | LGS-3185-W |
| Cold Water Gooseneck with Vacuum Breaker | LGS-3185-WV |
| Distilled Water | LGS-3185-D |
| Gas | LGS-3185-G |
| Nitrogen | LGS-3185-N |

Service Fitting Color Codes:

| | |
|-----------------|-------------|
| Air | Orange |
| Cold Water | Dark Green |
| Distilled Water | White |
| Gas | Dark blue |
| Hot Water | Red |
| Hydrogen | Pink |
| Nitrogen | Brown |
| Oxygen | Light Green |
| Special Gases | Light Blue |
| Steam | Black |
| Vacuum | Yellow |

Fume Hood Worktops

These modified black epoxy resin worktops are dished to retain spills. They are available with or without a cup sink hole or a 2" diameter vent hole. Use the vent hole for venting acid storage base cabinets. These worktops are custom manufactured for your hood.



| Width, Ft | Cat. No. |
|-----------|----------|
| 4 | WL-48B |
| 5 | WL-60B |
| 6 | WL-72B |
| 8 | WL-96B |

TEL-AFA500 Alarm

The TEL-AFA-500 Monitors the fume hood face velocity and sounds an alarm when the airflow falls below safe levels. Consisting of a thermostat sensor (mounted through the end of the fume hood) and a control monitor (mounted on the fascia), the unit gives both a visual and audible alarm. A glowing green light signals when conditions are safe. Control monitor also contains a test/reset button allowing the user to verify alarm readiness. The TEL-AFA-500 operates on a 9V DC circuit and comes complete with an adapter that can be plugged into any 120 VAC Receptacle.



Work Surfaces & Wall Shelving

Work Surfaces

The choice of lab work surface material is critical to your applications. We offer many work surface options from in stock products to custom fabricated work tops. All materials can be ordered to meet your specific size and space requirements. Let us help you make the right work surface choice.

| Material | Composition | Properties | Chemical Resistance | Heat Resistance | Standard Color | Impact/Abrasion Resistance |
|------------------|--|--|--|-----------------------|--------------------|----------------------------|
| Trespa | Phenolic resin laminate of high-pressure thermoset plastic material, 1" thick | Excellent resistance to chemicals, easy to clean | Better protection than epoxy resin against many acids, alkalis, and solvents | Fair No open flame | Black, white, gray | Fair |
| Plastic Laminate | Formulation of craft papers impregnated with phenolic resin | Low moisture, wear, and some heat resistance | Moderate chemical resistance | Fair No open flame | Many choices | Fair |
| Stainless Steel | 14-gauge, Type 304 solid stainless steel with reinforced hat channel | Extremely hygienic, excellent resistance to heat & chemicals | Superior corrosion resistance | Excellent | Silver | Excellent |
| Maple Hardwood | Maple planks glued together, sanded smooth with a baked on finish or penetrating oil | Excellent for mechanical or physical work levels | Marginal | Fair No open flame | Light wood color | Good |

Wall Shelving

Wall shelving is a great way to pick up valuable storage space for your laboratory materials. Fixed shelving provides stability and consistency for your storage needs. Our durable slotted adjustable system gives you flexibility when you need it. The 'bookend' style brackets help contain stored items on the shelf. We suggest the use of phenolic resin or plastic laminate for your shelves. These shelves are custom cut to suit your needs.



Fixed Heavy Duty Shelf Brackets

- LSM-11 11" Deep
- LSM-15 15" Deep
- LSM-20 20" Deep



Adjustable Shelving Uprights

- LRDS-30 30" L

High-strength, double slotted steel shelf support upright allows adjustable shelf brackets to be positioned for maximum use of space.

Adjustable Bookend Shelf Brackets

- Right Wall Shelf Bracket
- LRR-12R 12" R
 - LRR-16R 16" R
 - LRR-18R 18" R

- Left Wall Shelf Brackets
- LRR-12L 12" L
 - LRR-16L 16" L
 - LRR-18L 18" L

Island Shelving and Racking

The demand for usable horizontal space on a peninsula or island bench is significant. We offer a number of simple yet effective ways to maximize this available space.

Pole Style Reagent Shelving

The shelving with this system is held in place with 1" thick painted steel poles that are bolted through the work surface and shelf. It's a thoroughly ridged system and can be designed to almost any length or width. It can be tiered for increased storage space.



Reagent shelving is ordered separately

| Model | Size |
|---------|----------|
| LBRP-12 | 12" Tall |
| LBRP-15 | 15" Tall |
| LBRP-18 | 18" Tall |
| LBRP-21 | 21" Tall |

Note: All hardware is included with each pole

Adjustable Shelving Systems

- We have column and tower shelving systems to suit most any laboratory environment.
- The double slotted column system is an easy and effective way to create flexible storage space above your laboratory bench. Bookend style brackets are used to hold the adjustable shelves in place. Columns can also act as a support for a horizontal wire raceway.
- The enclosures of the tower system can serve as a conveyance for both plumbed as well as wired services. Services run vertically can provide for an unencumbered pass through work top. Bookend style brackets are used to hold the adjustable shelves in place.
- Each of these systems are designed on a job specific basis. We can help design a system for you.



Column System



Tower System

Fixtures by WaterSaver

Laboratory Ball Valves

Complete with 3/8" I.P.S. tank nipple. Specify Service desired.

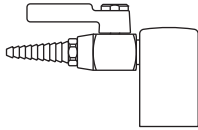

LB4200-131WSA
Gas, Air or Vacuum Deck Mounted Fitting is chrome plated brass. Valve provides on/off control of gas, air or vacuum at pressures up to 75 PSI.

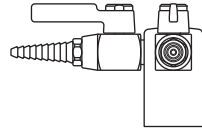

LB4200-132WSA
Double Gas, Air or Vacuum Deck Mounted Fitting same as No. TLW4200-131WSA except consists of a 2-way 90 degree outlet turret and two laboratory ball valves.

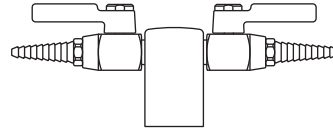

LB4200-132SWSA
Double Gas, Air or Vacuum Deck Mounted Fitting same as No. TLW4200-131WSA except consists of a 2-way 180 degree outlet turret and two laboratory ball valves.

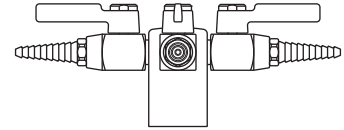

LB4200-134WSA
Double Gas, Air or Vacuum Deck Mounted Fitting same as No. TLW4200-131WSA except consists of a 4-way outlet turret and four laboratory ball valves.

Faucets

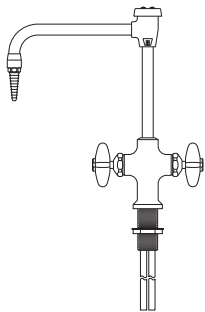

LB-411-VB
Deck Mounted Hot and Cold Water Mixing Gooseneck Faucet Made of chrome plated brass with an 8" spread rigid gooseneck. Removable straight serrated hose connector. Valves are disc type with renewable internal assemblies.

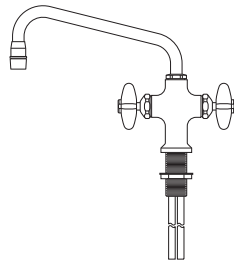

LB-410
Deck Mounted Hot and Cold Water Mixing Swing Spout Faucet Made of chrome plated brass. Has a 9" spread swinging spout with antisplash outlet. Valves are disc type with renewable internal assemblies.

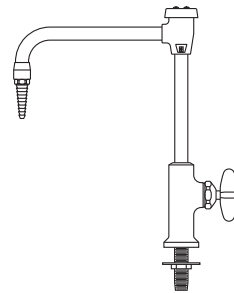

LB-411-8VB
Deck Mounted Chrome plated brass with an 8" spread rigid vacuum breaker type gooseneck. Removable straight serrated hose connector. Valve is disc type with a renewable internal assembly.

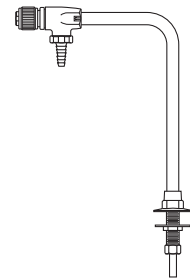

LB-7833
Distilled, Deionized and Ultra-Pure Water Faucet (deck mounted) made of chrome plated brass. All polypropylene internal construction with 6" spread gooseneck.

Emergency Equipment & Electrical Fixtures

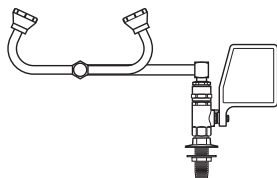

LB805
Eye Wash (deck mounted) with two Gentle Spray outlet heads, stay-open ball valve and 90° swivel feature. Right or left hand mounting.

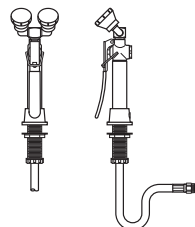

LB-1022
Deck Mounted Dual Purpose Eye Wash/Drench Hose with two Gentle Spray outlet heads angled at 45° and squeeze valve with locking clip.

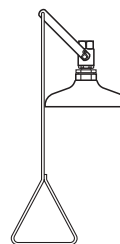

LB-635
Emergency Shower Head Assembly Includes 10" diameter orange ABS plastic shower head. Operated by a rigid pull-rod and easy to grip handle.



Electrical pedestals are available in a variety of styles and configurations. They can provide for as many as 8 outlets from a single pedestal and can also act to house communication services.

Sinks & Pegboards

Sinks

Dimensions Key

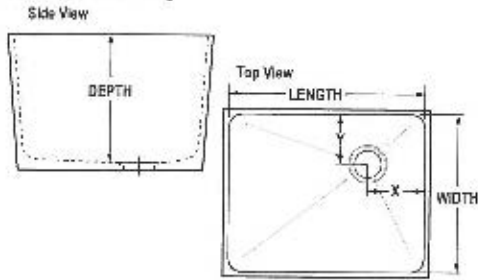

Epoxy resin sinks are available in black and gray

| Sink No. | Weight (lb) | Length | Width | Depth | Outlet |
|----------|-------------|--------|-------|-------|--------|
| LB103 | 17 | 12.0 | 8.0 | 6.0 | Center |
| LB115 | 34 | 16.0 | 12.0 | 8.0 | Center |
| LB120 | 39 | 16.0 | 16.0 | 7.5 | Corner |
| LB130 | 49 | 18.0 | 15.0 | 11.0 | Corner |
| LB133 | 64 | 21.0 | 17.0 | 10.0 | End |
| LB140 | 47 | 21.3 | 15.5 | 7.0 | Corner |
| LB145 | 64 | 21.5 | 15.5 | 11.00 | Corner |
| LB155 | 60 | 25.0 | 15.0 | 10.0 | Corner |
| LB159 | 65 | 28.0 | 15.0 | 12.0 | End |
| LB163 | 75 | 31.0 | 17.0 | 10.0 | End |

- Many more standard under mount and drop in sinks are available
- All sinks come with tail piece outlet

Pegboards

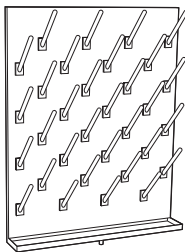

Stainless Steel Pegboard

- LB-SS2430 24" W x 30" H
- LB-SS3630 36" W x 30" H
- LB-SS4836 48" W x 36" H

Phenolic Resin Pegboard

- LB-PR2430 24" W x 30" H
- LB-PR3630 36" W x 30" H
- LB-PR4836 48" W x 36" H



Plexiglass splash guards and pegboards are also available

